

Part number

C30MA 70 P



Male crimp contact, C30 series, 300 A, turned silver plated, wire cross section 70 mm², AWG 2/0, finger-proof version

Product description		Material properties	
Product type	Crimp contact	Main material	Copper alloy
Series	C30	Other materials	Cap: polycarbonate (PC)
Gender	Male		Compliant with exemption 6(c): copper alloy containing up to 4% lead by weight
Specification	Finger-proof version	RoHs conformity	
Technical data		China RoHs - EFUP	50
Current	300 A	REACH SVHC substances	Yes Lead
Wire cross-section	70,00 mm ²	General ordering information	
Contact type	Turned silver plated	EAN13 code	8015747290890
Further technical details		Packaging Information	
Contact resistance	≤ 0,2 mΩ	Packaging length	112,00 mm
Weight	39,20 g	Packaging height	95,00 mm
Conductors stripping length	22,5 mm	Packaging width	117,00 mm
		Packaging volume	1,24 dm ³
		Packaging description	Carton box
		Packaging quantity	40 Pcs
		Packaging EAN code	8015747290920
		Sub-packaging length	50,00 mm
		Sub-packaging height	44,00 mm
		Sub-packaging width	50,00 mm
		Sub-packaging volume	0,11 dm ³
		Sub-packaging description	Plastic box
		Sub-packaging quantity	5 Pcs
		Sub-packaging EAN barcode	8015747290937

Part number

C30MA 70 P



Catalogue drawings

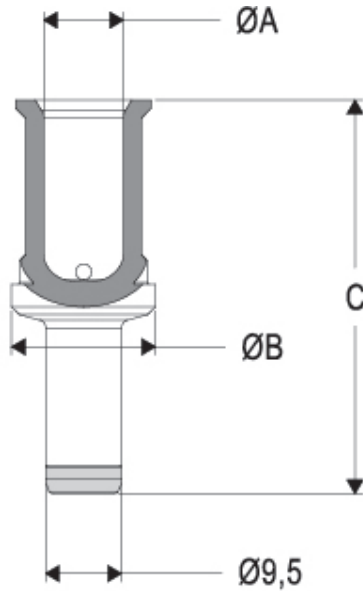

C30MA..P contacts

conductor section (mm ²)	conductor slot \varnothing A (mm)	\varnothing B (mm)	C (mm)	conductor stripping length (mm)
16	5,5	18	42,7	19
25	7	18	42,7	19
35	8,2	18	43,7	20
50	10	18	49,2	22,5
70	11,5	18	49,2	22,5
95	13,5	21	49,2	22,5
120	15,5	21	49,2	22,5

Notes

AVAILABLE FROM: JUNE 2023

California Proposition 65 Information



WARNING

This product can expose you to lead and its compounds, known to the State of California to cause cancer and/or reproductive toxicity. For more information go to www.P65Warnings.ca.gov.

Dimensions shown in mm are not binding and may be changed without notice.
