

Modular Power Analyzer UMG 801

User manual and technical data



UMG 801
Modular multifunctional meter for
recording energy quantities

Doc. no.: 2.053.021.3.d

Date: 11/2023

The German version is the original edition of the documentation

 **INFORMATION**

The content of this document reflects the measurement device firmware version 1.5.0, which was current at the time of creation. Check for the presently current version (www.janitza.com) and keep the measurement device firmware up to date!

Subject to technical alterations.

The contents of our documentation have been compiled with great care and reflect the current state of the information available to us. Nonetheless, we wish to point out that updates of this document are not always possible at the same time as technical refinements are implemented in our products. Please see our website under www.janitza.com for the current version.

Please see our website under www.janitza.com for the current version.

Information about the GridVis® software.

 Janipedia: wiki.janitza.de

 Tutorials: youtube.com/@gridvis

Table of content

1. Information on the device and the user manual	12
1.1 Disclaimer.....	12
1.2 Copyright notice.....	12
1.3 Technical changes.....	12
1.4 About this user manual.....	12
1.5 Defective device/disposal.....	13
2. Safety	14
2.1 Display of warning notices and safety information.....	14
2.2 Hazard levels.....	14
2.3 Product safety.....	14
2.4 Dangers when handling the device.....	15
2.5 Electrically qualified personnel.....	16
2.6 Warranty in the event of damage.....	16
2.7 Safety information for handling current transformers.....	16
2.8 Safety information for handling measurement devices with residual current measurement.....	17
2.9 Handling batteries/accumulators.....	17
3. Product description	18
3.1 Device description.....	18
3.2 Incoming goods inspection.....	19
3.3 Intended use.....	19
3.4 Performance characteristics.....	20
3.5 Conformity declaration.....	20
3.6 FCC Declaration of Conformity.....	20
3.7 Scope of delivery.....	21
3.8 Accessories.....	21
3.9 Measuring method.....	22
3.10 Transformers.....	22
3.11 Operating concept.....	22
3.12 Web server with device homepage.....	23
3.13 GridVis® network analysis software.....	23

3.14	Overview of the range of functions.....	23
3.14.1	Configuration on the device (via 6 buttons).....	23
3.14.2	Communication.....	23
3.14.3	Measured values (with voltage component).....	24
3.14.4	Measured values (with current component).....	24
4.	Structure of the device.....	26
4.1	Front panel and display.....	26
4.2	Side views (device without terminals).....	28
4.3	Bottom view (device without terminals).....	28
4.4	Identification of the device (rating plate).....	29
5.	Mounting.....	30
5.1	Installation location.....	30
5.2	Bus connector.....	31
5.3	DIN rail mounting of the device.....	31
6.	Grid systems.....	33
7.	Installation.....	34
7.1	Nominal voltages.....	34
7.2	Circuit breaker.....	35
7.3	Supply voltage.....	35
7.4	Voltage measurement.....	36
7.4.1	Overvoltage.....	36
7.4.2	Mains frequency.....	36
7.4.3	Connection variants for voltage measurement.....	37
7.5	Current measurement.....	38
7.5.1	Connection variants for current measurement.....	39
7.5.2	Summation current measurement.....	40
7.5.3	Ammeter.....	40
7.6	Multifunction channels.....	40

7.7	Residual current measurement (RCM).....	41
7.7.1	Current direction of the residual current transformers.....	42
7.7.2	Residual current transformer example.....	42
7.7.3	Important information about the residual current measurement inputs.....	42
7.7.4	Connection examples - Residual current measurement.....	43
7.7.5	Connection example - Residual current monitoring.....	44
7.8	Residual current measurement - limit value calculation.....	45
7.8.1	Static limit value calculation.....	45
7.8.2	Dynamic limit value calculation.....	46
7.8.3	Stepwise limit value calculation.....	47
7.8.4	Example: Residual current limit value exceeded.....	48
7.8.5	Activating cable break detection (failure monitoring) RCM for the multifunction channels.....	49
7.9	Temperature measurement.....	50
8.	Communication via the Ethernet interfaces.....	52
8.1	Functions of the Ethernet interfaces.....	52
8.2	"Switched mode" connection option.....	53
8.3	"Dedicated mode" connection option.....	53
8.4	Meaning of the Ethernet interface LEDs:.....	53
9.	PC connections and other interfaces.....	54
9.1	PC connections.....	54
9.2	RS-485 interface (serial interface).....	56
9.2.1	Shielding.....	57
9.2.2	Termination resistors/Termination.....	57
9.2.3	Bus structure (bus segment).....	58
9.3	JanBus interface.....	58
9.4	Digital inputs.....	59
9.5	Digital outputs.....	60
9.6	Analog outputs.....	61

10. Operation and button functions	62
10.1 Controls.....	62
10.2 Function buttons.....	62
10.3 Measuring display.....	62
10.4 Menu.....	62
10.5 PIN (password).....	63
10.6 Overview of menu displays.....	64
11. Configuration	66
11.1 The Configuration window.....	66
11.2 Configuring Ethernet (TCP/IP).....	66
11.2.1 Communication via TCP/IP.....	67
11.2.2 Communication via OPC UA.....	67
11.3 Configuring the fieldbus (RS-485 interface).....	68
11.3.1 Communication settings.....	68
11.4 Configuring current transformers.....	69
11.5 Configuring voltage transformers.....	70
11.6 Temperature measurement configuration.....	71
11.6.1 Temperature sensor types.....	71
11.6.2 "Temperature offset" item.....	71
11.7 Configuring the display.....	72
11.7.1 Language.....	72
11.7.2 Standby (after).....	72
11.7.3 Brightness.....	73
11.8 Configuring the system.....	73
11.8.1 PIN.....	73
11.8.2 Restart (reboot).....	74
11.8.3 Time.....	74
11.8.4 Date.....	74
11.9 Reset.....	75
11.9.1 Standard factory settings.....	75
11.9.2 Reset configuration.....	75
11.9.3 Reset minimum, maximum and average values.....	76
11.9.4 Reset energy values.....	76
11.9.5 Reset historical data.....	77

11.10	Module identification / diagnostics.....	77
11.11	Events and transients.....	78
11.11.1	Events.....	78
11.11.2	Transients.....	78
11.11.3	Event and transient recording.....	79
11.11.4	Configuration of the waveform for events and transients.....	80
11.11.5	Half-wave RMS values for events.....	80
11.11.6	Update time for transients.....	81
11.11.7	Event and transient configuration in the GridVis software.....	81
11.11.8	Flicker.....	82
12.	Digital inputs and outputs.....	84
12.1	4 digital inputs.....	84
12.2	4 digital outputs.....	86
12.3	Comparator.....	88
13.	Analog outputs.....	92
14.	Commissioning.....	94
14.1	Supply voltage.....	94
14.2	Measured voltage.....	94
14.3	Measured current.....	95
14.4	Frequency measurement.....	95
14.5	Direction of rotary field.....	96
14.6	Fundamentals on the phasor diagram.....	96
14.7	Checking of voltage and current inputs by means of phasor diagram.....	97
14.8	Checking the phase assignment.....	97
14.9	Checking the power measurement.....	98
14.10	Checking measurement.....	98
14.11	Checking individual power.....	98
14.12	Checking summation power.....	98
14.13	Drag indicator function.....	99
14.13.1	Configuring the drag indicator synchronization.....	99
14.13.2	Drag indicator - measurement device display.....	101
14.13.3	Resetting the drag indicator.....	102

14.14	Average value - gridded and moving.....	102
14.14.1	Gridded average value.....	102
14.14.2	Moving average value.....	103
14.14.3	Gridded and moving average in the GridVis® software	103
15.	Overview of measured value and meter displays.....	104
16.	Connection example.....	118
17.	Dismounting.....	119
18.	Device homepage.....	120
18.1	"Home" start page.....	120
18.1.1	Login.....	121
18.1.2	Change password.....	122
18.2	"Measured values" menu bar item.....	123
18.2.1	Details.....	123
18.2.2	Events and transients.....	124
18.3	"Settings" menu bar item.....	125
18.3.1	Firmware update.....	126
18.3.2	Whitelist (Modbus port 502).....	127
18.4	"Information" menu bar item.....	128
18.4.1	Device information.....	128
18.4.2	Modbus address list.....	129
18.4.3	Imprint.....	129
19.	Service and maintenance.....	130
19.1	Repair and calibration.....	130
19.2	Front panel foil and display.....	130
19.3	Service.....	130
19.4	Device adjustment.....	131
19.5	Firmware update via the device homepage.....	131
19.6	Firmware update via the GridVis® software.....	131
19.7	Clock/Battery.....	131
19.8	Battery replacement.....	131

20. Error messages	132
20.1 Overrange.....	132
20.2 Procedure in the event of a malfunction.....	133
21. Technical specifications	134
21.1 Technical data.....	134
21.2 Performance characteristics of functions.....	142
21.3 Parameter and Modbus address list.....	143
21.4 Information on saving measured values and configuration data.....	143
22. Dimensional drawings	144
22.1 Basic device UMG 801	144
22.2 Bus connector.....	145

1. Information on the device and the user manual

1.1 Disclaimer

Compliance with the informational products for the device is a prerequisite for safe operation and attaining the stated performance characteristics and product features.

Janitza electronics GmbH assumes no liability for bodily injury, material damage or financial losses which result from disregard of the informational products.

Ensure that your informational products are readily accessible in a legible form.

1.2 Copyright notice

© 2023 - Janitza electronics GmbH - Lahnau. All rights reserved.

Any reproduction, processing, distribution or other use of this informational product, in whole or in part, is prohibited.

All trademarks and the rights arising from them are the property of the respective owners of these rights.

1.3 Technical changes

- Make sure that your device (modules/components) matches the user manual.
- This user manual applies to the UMG 801. Separate validities and distinctions are marked.
- First make sure you have read and understood the usage information accompanying the product.
- Keep the usage information associated with the product available for the entire service life and pass it on to any possible subsequent users.
- Find out about device revisions and the associated modifications of the usage information associated with your product at www.janitza.com.

1.4 About this user manual

If you have questions, suggestions or ideas for improvement of the user manual, please let us know via email at: info@janitza.com.

INFORMATION

This user manual describes the UMG 801 and provides information on the operation of the device.

Also consult the additional documentation relevant for this user manual, such as:

- the installation manual.
- the data sheet.
- the "Safety information" supplement.
- if applicable, the usage information of the integrated modules and components of your meter and module topology (e.g. current transformers).

Moreover, the **GridVis® software** has an "online help" feature.

The illustrations and figures in this user manual may differ from the actual state of the device delivered!

INFORMATION

Our usage information uses the grammatical masculine form in a gender-neutral sense! This form always refers equally to women, men and diverse. In order to make the texts more readable, distinctions are not made. We ask for your understanding for these simplifications.

1.5 Defective device/disposal

Before sending **defective devices, modules or components** back to the manufacturer for testing:

- Contact the manufacturer's Support department.
- Send devices, modules or components complete with all accessories.
- When doing so, please bear the terms for transportation in mind.

Do not attempt to open or repair the device (the module, the component) on your own because otherwise all warranty claims become invalid!

For the **disposal** of the device (the module, the component), please observe national regulations! Dispose of individual parts, as applicable, depending on their composition and existing country-specific regulations, for example, as

- Electronic waste,
- Batteries and rechargeable batteries,
- Plastics,
- Metals.

Engage a certified disposal company to handle scrapping as needed.

Information on service and maintenance of your device can be found in chapter „19. Service and maintenance“ on page 130.

2. Safety

The chapter on Safety contains information which must be observed to ensure your personal safety and avoid material damage.

2.1 Display of warning notices and safety information

The warning notices shown below

- are found throughout all of the documentation,
- can be found on the devices themselves.
- indicate potential risks and hazards,
- underscore aspects of the information provided that clarifies or simplifies procedures.



The additional symbol on the device itself indicates an electrical danger that can result in serious injuries or death.



This general warning symbol draws attention to a possible risk of injury. Be certain to observe all of the information listed under this symbol in order to avoid possible injury or even death.



2.2 Hazard levels

Warning and safety information is marked by a warning symbol, and the hazard levels are shown as follows, depending on the degree of hazard:

DANGER

Warns of an imminent danger which, if not avoided, results in serious or fatal injury.

WARNING

Warns of a potentially hazardous situation which, if not avoided, could result in serious injury or death.

CAUTION

Warns of an immediately hazardous situation which, if not avoided, can result in minor or moderate injury.

ATTENTION

Warns of an immediately hazardous situation which, if not avoided, can result in material or environmental damage.

INFORMATION

Indicates procedures in which there is **no** hazard of personal injury or material damage.

2.3 Product safety

The devices, components and modules reflect current engineering practice and accepted safety standards, but hazards can arise nonetheless.

Observe the safety regulations and warning notices. If notices are disregarded, this can lead to personal injury and/or damage to the product.

Every type of tampering with or use of this device,

- which goes beyond the mechanical, electrical or other operating limits can lead to personal injury and/or damage to the product;
- constitutes “misuse” and/or “negligence” under the product’s warranty and thus voids the warranty for any possible resulting damage.

Before installing, operating, maintaining and using the device, read and understand the user manual and the device usage information. As applicable, also observe all further usage information on the components and modules of your system.

Only operate the device when it is in perfect condition and in compliance with this user manual and the enclosed usage information. Send defective devices back to the manufacturer in compliance with proper transport conditions.

Retain the user manual throughout the service life of the device and keep it at hand for consultation.

When using the device, also observe the legal and safety regulations for your system that are applicable for the respective use case.

2.4 Dangers when handling the device

When operating electric devices, components or modules, it is unavoidable for certain parts of these devices to conduct hazardous voltage. Consequently, severe bodily injury or material damage can occur if they are not handled properly.

Therefore, when handling our devices, components, or modules, always observe the following:

- Do not exceed the limit values specified in the user manual and on the rating plate! This must also be observed during testing and commissioning!
- Take note of the safety and warning notices in all usage information that belongs to the device, components or modules!

WARNING

Disregarding the connection conditions of the Janitza measurement devices, modules or components can lead to injuries or even death or to material damage!

- Do not use Janitza meters, modules or components for critical switching, control or protection applications where the safety of persons and property depends on this function.
- Do not carry out switching operations with the Janitza measurement devices, modules or components without prior inspection by your system manager with specialist knowledge! In particular, the safety of persons, material assets and the applicable standards must be taken into account!

WARNING

Risk of injury due to electrical currents and voltages!

Severe bodily injury or death can result! Therefore please abide by the following:

- **Switch off your installation before commencing work! Secure it against being switched on! Check to be sure it is de-energized! Ground and short circuit! Cover or block off adjacent live parts!**
- **During operation and troubleshooting (especially with DIN rail devices), check the environment for dangerous voltages and switch these off if necessary!**
- **Wear protective clothing and protective equipment in accordance with applicable guidelines when working on electrical systems!**
- **Before making connections, ground the device / component / module by means of the ground wire connection, if present!**
- **Do not touch bare, stripped wires or device inputs that are dangerous to touch on the devices, components and modules. Equip stranded conductors with wire ferrules!**
- **Hazardous voltages can be present in all circuitry parts that are connected to the power supply.**
- **Protect wires, cables and devices with a suitable line circuit breaker/fuse!**
- **Never switch off, remove or tamper with safety devices!**
- **There can still be hazardous voltages present in the device or in the component (module) even after it has been disconnected from the supply voltage (capacitor storage).**
- **Do not operate equipment with current transformer circuits with $\geq 5A$ (1A) current transformers with exposed connections.**
- **Only connect screw terminals and spring terminals with the same number of poles and design!**
- **Do not exceed the limit values specified in the user manual and on the rating plate! This must also be observed during testing and commissioning.**
- **Take note of the safety and warning notices in the usage information that belongs to the device, components or modules!**

2.5 Electrically qualified personnel

To avoid bodily injury and material damage, only electrically qualified personnel are permitted to work on the devices and their components, modules, assemblies, systems and current circuits who have knowledge of:

- The national and international accident prevention regulations.
- Safety technology standards.
- Installation, commissioning, operation, disconnection, grounding and marking of electrical equipment.
- The requirements concerning personal protective equipment.

Electrically qualified persons within the scope of the technical safety information of all usage information associated with the device and its components (modules) are persons who can furnish proof of qualification as an electrically skilled person.

WARNING

Warning against unauthorized manipulation or improper use of the device or its components (modules)!

Opening, dismantling or unauthorized manipulation of the device and its components which goes beyond the mechanical, electrical or other operating limits indicated can lead to material damage or injury, up to and including death.

- **Only electrically qualified personnel are permitted to work on the devices and their components (modules), assemblies, systems and current circuits.**
- **Always use your devices or components (modules) only in the manner described in the associated usage information.**
- **If there is discernible damage, send the device or the component (module) back to the manufacturer!**

2.6 Warranty in the event of damage

Any unauthorized tampering with or use of the device, component or module constitutes "misuse" and/or "negligence" under the product's warranty and thus voids the warranty for any possible resulting damage. In this regard, please take note of section „3.3 Intended use“ on page 19.

2.7 Safety information for handling current transformers

The field of transformer technology groups the totality of all devices that perform the function of a **current, voltage** or **measuring transformer** together as **sensors**.

In the usage information for our devices, modules and components, the terms **current transformer**, **voltage transformer** or **transformer** all refer to **sensors**.

A further distinction is made by the terms **CT (current transformer)** and **LP-CT (low-power current transformer)**:

The term "**current transformer**" is used for special transformers for the primary-proportional conversion of currents of large magnitudes to directly measurable, **smaller current values**. In contrast, the term "**LP current transformer**" is used for special transformers for the primary-proportional conversion of currents of large magnitudes to directly measurable **voltage values (low power)**.

Current transformers and **LP current transformers** provide safe galvanic isolation between the primary circuit and the measurement circuit due to their design and their physical operating principle. For Janitza measurement devices, modules and components, use only "**transformers for measuring purposes**" which are suitable for the energy monitoring of your system! Please note Sect. "3.10 Transformers" on p. 22 and Sect. "7. Installation" on p. 34 in this regard!

The UMG 801 basic device uses the term "**current transformer**" only in the display for the configuration of both **current transformers** and **LP current transformers**.

⚠ WARNING**Risk of injury due to large currents and high electrical voltage on the current transformers!**

Current transformers operated while open on the secondary side (high voltage peaks pose a hazard when touched) can result in severe bodily injury or death.

- **Avoid operating the current transformers while open; short circuit the unloaded transformers!**
- **Before interrupting the current supply, short circuit the secondary connections of the current transformers. Switch any test switches that automatically short circuit the secondary lines of the current transformers to the "Test" status (Check the test switch/short circuiting connection beforehand)!**
- **Only use current transformers with basic insulation to IEC 61010-1:2010!**
- **Caution, even current transformers rated as safe for open operation can pose a hazard when touched during operation while open!**
- **Make sure that screw terminals for the current transformer connection on the device are adequately tightened!**
- **Comply with the information and provisions in the documentation of your current transformers!**

⚠ CAUTION**Risk of injury or damage to the meter due to high measurement currents at the connections of the current transformers!**

High measurement currents can cause temperatures of up to 80 °C (176 °F) on the connections of the current transformers

- **Use wiring that is designed for an operating temperature of at least 80 °C (176 °F)!**
- **The current transformers can be hot even after the power supply has been switched off. Allow the connections of the current transformers and the connecting cables to cool down before touching them!**

⚠ CAUTION**Risk of injury or damage to the basic device (module) and/or your system due to a short circuit!**

Inadequate insulation at the current measurement inputs of the modules with respect to the supply circuits of the basic device can cause dangerous voltages at the measurement input or damage to your device (module)/system.

- **Ensure reinforced or double insulation with respect to the supply circuits!**

2.8 Safety information for handling measurement devices with residual current measurement**⚠ WARNING****Risk of injury or damage to the meter due to improper use!**

Meters with residual current measurement can trigger warning pulses if limit values are exceeded, and these are used exclusively for monitoring residual currents or failure monitoring. Use of the warning pulses as a stand-alone protective device against electrical shock can lead to injury and even death!

- **Do not use devices with residual current measurement as a stand-alone protective device. Employ suitable protective devices for your system!**

⚠ CAUTION**Risk of injury or damage to the meter/your system due to short circuit!**

Inadequate insulation of the operating equipment at the residual current measurement input with respect to the supply circuits can cause voltages at the measurement input which represent a hazard when touched or damage to your device or system.

- **Ensure reinforced or double insulation with respect to the supply circuits!**
- **Ensure galvanic isolation of the residual current measurement inputs from each other!**

2.9 Handling batteries/accumulators

The following apply for the battery used in the device:

⚠ CAUTION**Risk of injury due to fire or burns!**

The battery used in the device may cause fire or burns if used improperly.

- **Only replace the battery with the same type or types recommended by Janitza!**
- **Observe the polarity when installing the battery!**
- **Remove batteries only with non-conductive tools (e.g. plastic tweezers)!**
- **Do not recharge, disassemble, burn or heat batteries above 100 °C (212 °F)!**
- **Do not dispose of batteries with household waste! Follow the disposal instructions in the respective device documentation!**
- **Keep batteries away from children and animals!**
- **In case of damage, return devices with a soldered battery to the manufacturer, observing proper transport conditions!**

3. Product description

3.1 Device description



Fig.: UMG 801 measurement device (without terminals)

The measurement device is a multifunctional network analyzer and is suitable for:

- Measurements and calculations of electrical quantities such as voltage, current, power, energy, harmonics current in building installations, on distribution boards, circuit breakers and busbar trunking systems.
- An expansion of the range of functions using modules.
- The connection of remote measurement points in the switchboard cabinet or small installation distributors via transfer modules.
- Measurements of voltages and currents from the same network.
- Measurements in low-voltage networks (3-phase 4-conductor systems) in which nominal voltages of up to 480 V from conductors to ground and surge voltages of overvoltage category III occur.
- Measurements in medium and high voltage networks via current and voltage transformers.
- Current measurement via
 - external $\dots/1$ A or $\dots/5$ A current transformers.
 - the multifunction channels (mA current inputs).
- Installation in stationary switch cabinets or small distribution boards, in any mounting orientation.
- The measurement of residual currents (Residual Current Monitoring, RCM) of an electrical system. The measurement device is not a protective device against electric shock!
- Use in industrial areas.

Measurement results are displayed by the measurement device and can be read and processed via interfaces.

⚠ CAUTION

Malfunction and damage of the device or risk of injury due to improper connection.

Improperly connected devices can deliver incorrect measured values, damage the device or pose a risk of injury to persons.

Observe the following:

- **That measured voltages and currents come from the same network.**
- **Do not use the device for measuring direct current!**
- **Ground current-conducting switchboards!**

3.2 Incoming goods inspection

Safe and trouble-free operation of this measurement device (with its modules and components) presupposes proper transport, storage, setup and assembly as well as operation and maintenance in addition to compliance with the safety information and warning notices.

Exercise due caution when unpacking and packing the device, do not use force and only use suitable tools. Check the following:

- The measurement device by visually checking that it is in perfect mechanical condition.
- the scope of delivery for completeness before beginning with assembly and installation.

If it can be assumed that safe operation of your measurement device is not possible, disconnect the measurement device immediately. To avoid electrical accidents, follow the 5 safety rules as follows:

1. **Disconnect the system (devices, as applicable modules and components also)!**
2. **Secure it against being switched on!**
3. **Check to be sure it is de-energized!**
4. **Earth and short circuit the system (devices, as applicable modules and components also)!**
5. **Cover or block off adjacent live parts!**

Safe operation is impossible, if the measurement device:

- has visible damage,
- no longer functions despite an intact power supply,
- was subjected to extended periods of unfavorable conditions (e.g. storage outside of the permissible climate conditions without adaptation to the room climate, condensation, etc.) or transport stress (e.g. falling from an elevated position, even without visible external damage, etc.).

ATTENTION

Improper handling can damage the measurement device (possibly also modules and components) and lead to material damage!

The contacts of JanBus interfaces can bend or break off and destroy the interface.

- **Never touch or manipulate the contacts of Jan-Bus interfaces!**
- **Never use force to mount bus connectors, modules and components! Please refer to the chapters "Mounting" and "Dismounting" here in the user manual and, if applicable, in the usage information of the modules and components that are used!**
- **Protect the contacts of the interfaces when handling, transporting and storing the measurement device (as applicable, the modules and components as well)!**

3.3 Intended use

The measurement device is

- Only for use in the industrial sector.
- Intended for installation in switchboard cabinets and small distribution boards.
- Designed as an indoor meter.

The measurement device is **not** for installation

- In vehicles! Use of the device in non-stationary equipment constitutes an exceptional environmental condition and is only permissible by special agreement.
- In environments with harmful oils, acids, gases, vapors, dusts, radiation, etc.

Safe and trouble-free operation of the measurement device requires proper transport, storage, assembly, installation, operation and maintenance.

3.4 Performance characteristics

General

- DIN rail measurement device with the dimensions W: 144 mm x H: 90 mm x D: 76 mm.
- Mounting on 35 mm DIN rail (for types see section "Technical data").
- TFT display.
- Operation via 6 buttons.
- Password protection.
- Connection via screw and spring terminals.
- 4 voltage measurement inputs (1000 V, CATIII).
- 2x 4 current measurement inputs (via current transformer).
- RS-485 interface (Modbus RTU, with DIP switch for termination).
- 2x Ethernet interface (RJ45).
- 4 digital inputs.
- 4 digital outputs.
- 1 analog output (galvanically isolated).
- 4 multifunction channels for use as residual current or temperature measurement inputs and additional current measurement channels (mA).
- Clock and battery.
- Optional remote display (RD96) for convenient meter operation.
- Expandable with current measuring modules and digital input modules via transfer modules (see usage information for the respective modules).

Measurement uncertainty

- Active energy, measurement uncertainty class 0.2 S for ≤ 5 A transformers.
- Active energy, measurement uncertainty class 0.5 S for ≤ 1 A transformers.
- Active energy, measurement uncertainty class 0.5 S for ≤ 50 mA transformers.
- Reactive energy, class 1.

Measurement

- Measurement in TN, TT and IT networks.
- Measurement in networks with nominal voltages up to L-L 830 V and L-N 480 V.
- Measuring range, voltage $720 V_{\text{eff L-N}}$; $1000 V_{\text{eff L-L}}$; $100 V_{\text{N-PE}}$.
- Measuring range, current $0.005 \dots 6 A_{\text{eff}}$.
- True effective value measurement (TRMS).
- Continuous sampling of the voltage and current measurement inputs.
- Frequency range of the fundamental oscillation 40 Hz \dots 70 Hz.
- Voltage: 1..127 harmonics ($U_{\text{L-N}}$ and $U_{\text{L-L}}$) and interharmonics ($U_{\text{L-N}}$).
- Current: 1..63 harmonics.
- Residual current acc. to IEC/TR 60755 (2008-01), type A + type B and B+.

3.5 Conformity declaration

The laws, standards and directives applied by Janitza electronics GmbH for the devices can be found in the declarations of conformity at www.janitza.com.

3.6 FCC Declaration of Conformity



The device

- complies with Part 15 of the FCC Rules for Class B digital devices (limits to protect against harmful interference in a residential installation).
- generates, uses and can radiate high-frequency energy
- can cause harmful interference to radio communications if not installed and used properly. There is no guarantee that interference will not occur in a particular installation.

If there is radio or television reception interference, which can be determined by turning the device on and off, proceed as follows:

- Align or reposition the receiving antenna.
- Increase the distance between the device and the radio/television receiver.
- Connect the device and the radio/television receiver in different circuits.
- if necessary, contact Janitza support or a radio/television technician.

Code of Federal Regulations, Title 47, Part 15, Subpart B - Unintentional Radiators.

3.7 Scope of delivery

Quantity	Part. no.	Designation
1	52.31.xxx	UMG 801 (basic device)
1	52.31.205	Bus connector for module connection to the UMG 801 (basic device)
1	33.03.376	Installation manual DE/EN
1	33.03.342	Supplement "Safety Information"
1	08.01.505	Patch cable
1	52.31.260	Accessory pack (screw and spring terminals)

Tab. Scope of delivery

The device is delivered with the required terminals (accessory pack).

3.8 Accessories

Quantity	Part. no.	Designation
1	52.31.262	Accessory pack (only spring terminals)
1	21.01.058	Battery type, Lithium CR2032, 3 V, (approval according to UL 1642)
1	13.09.227	USB cover
1	52.31.230	Module 800-CT8-A (current measuring module for the UMG 801 as of FW version 1.5.0)
1	52.31.234	Module 800-CT8-LP (low-power current measuring module)
1	52.31.210	Set module 800-CON (set of 2 transfer modules)
1	52.31.214.	Module 800-DI14 (digital input module for the UMG 801 as of FW version 1.5.0)
1	52.31.212	RD 96 - External display
1	15.06.107	Interface converter RS-485 <-> USB

Tab. Accessories

INFORMATION

The delivery note documents all delivered options and design variants.

3.9 Measuring method

The device measures continuously and calculates all effective values using:

- A 200 ms period interval.
- The true RMS value (TRMS) of the voltages and currents applied to the measurement inputs.

3.10 Transformers

Use current transformers for measuring purposes ("measurement transformers") **exclusively** for Janitza measurement devices, modules and components! Please observe the warnings in this regard in Sect. "7. Installation" on p. 34.

"Transformers", unlike "protection transformers", go into saturation at high current peaks. "Protection transformers" do not have this saturation behavior and can therefore significantly exceed the rated values in the secondary circuit. This can overload the current measurement inputs of the measurement devices!

Furthermore, please note that Janitza measurement devices, modules and components are **not** to be used for critical switching, control or protection applications (protective relays)! Observe the safety and warning information in the "Installation" and "Product safety" chapters!

3.11 Operating concept

The following options are offered for operating, configuring or reading the meter:

- **6 function buttons with display** for configuration and acquisition of data.
- Web server with device homepage for analyzing and configuring the essential measurement device parameters (for more details, see Sect. "18. Device homepage" on p. 120).
- The **GridVis network analysis and programming software**® for programming and analysis of data.
- The RD 96 external display with 6 function buttons for reading out and configuring data.

INFORMATION

The external display RD 96 in combination with the UMG 801

- is used for front panel installation in a switchboard cabinet or on a small distribution board.
- ensures safe reading of measured values without having to open or touch live systems, system components, switchboard cabinets or small distribution boards!

For more information, please refer to the usage information for the RD 96.

A standard Modbus address list is available at www.janitza.com.

This user manual describes how to operate the meter using the 6 keys. The GridVis® software has an "online help".

3.12 Web server with device homepage

The measurement device has an integrated homepage, and information on this can be found in Sect. "18. Device homepage" on p. 120.

3.13 GridVis® network analysis software

With the GridVis® network analysis software available at www.janitza.com, you can configure your measurement device and read out data for analysis. To do so, connect a PC to your measurement device via the Ethernet interface.

Performance characteristics of the GridVis® software

- Configure and read out the device.
- Graphic display of measured values.
- Analysis of read data.
- Store data in databases.
- Create reports.

Connections to the PC

Connections for communication between the PC and the measurement device can be found in Sect. "9. PC connections and other interfaces" on p. 54.

3.14 Overview of the range of functions

3.14.1 Configuration on the device (via 6 buttons)

- Password protection and time.
- 2x Ethernet TCP/IP with autonomous network communication.
- Field bus.
- Current transformer/LP current transformer (for information, see Page 16) - primary / secondary.
- Voltage transformer primary / secondary.
- Language, LCD brightness, standby after
- Factory settings, restart, min./max. values.
- Parameters, such as
 - Device address, baud rate (RS-485 interface), data frame (stop bits / parity).

3.14.2 Communication

- One RS-485 interface for communication with Modbus/RTU devices.
- Firmware update via Ethernet.
- 2 Ethernet interfaces for communication via various IP protocols (OPC-UA, Modbus/IP, DHCP, NTP, HTTP(S) and FTP(S)).

3.14.3 Measured values (with voltage component)

Measured values (with voltage component)	Device/system related	Channel related	Min. value	Max. value	Average value
Frequency	1		✓	✓	✓
Rotating field direction U	1		✓ System		
Measurement of positive, negative, zero sequence component	1		✓	✓	✓
Imbalance in %	1		✓	✓	✓
Effective voltage U_{NPE_eff}	1			✓	
Effective voltage U_{LN_eff}		3	✓	✓	✓
Effective voltage U_{LL_eff}		3	✓	✓	✓
Distortion factor U_{LN_THD}		3	✓	✓	✓
Distortion factor U_{LL_THD}		3	✓	✓	✓
Real component Voltage $Re\{U_{LN}\}$		3	✓	✓	✓
Imaginary component Voltage $Im\{U_{LN}\}$		3	✓	✓	✓
Harmonic $U_{LN_1..127}$		3x127		✓	
Interharmonic $U_{LN_0.5..126.5}$		3x127		✓	
Harmonic $U_{LL_1..127}$		3x127		✓	
Crest factor $U_{LN-Crest}$	3		✓ System		

Table: Overview of the measured values recorded by the device.
For more information on the measured values, see section „21.2 Performance characteristics of functions“ on page 142.

3.14.4 Measured values (with current component)

Measured values (with current component)	Device/system related	Channel related	Min. value	Max. value	Average value
Effective current I_{eff}		12		✓	✓
Real part Current $Re\{I\}$		12		✓	✓
Imaginary part Current $Im\{I\}$		12		✓	✓
Active power P		12		✓	✓
Reactive power Q		12		✓	✓
Apparent power S		12		✓	✓
Reactive distortion power D		12		✓	✓
Active power of the fundamental oscillation P_1		12		✓	✓
Reactive power of the fundamental oscillation Q_1		12		✓	✓

Table: Overview of the measured values recorded by the device.
For more information on the measured values, see section „21.2 Performance characteristics of functions“ on page 142.

Measured values (with current component)	Device/system related	Channel related	Min. value	Max. value	Average value
Power factor PF		12	✓	✓	✓
Fundamental oscillation power factor PF ₁ / Cos(Phi)		12	✓	✓	✓
Distortion factor I _T HD		12		✓	✓
Power distortion factor I _T DD		12		✓	✓
Crest factor I _C rest		12			
Harmonic I		12			
Rotating field direction I			✓ System		
Measurement of positive, negative, zero sequence component	3			✓	✓
Calculated neutral conductor current I _N _calc	3			✓	✓
System total effective current I _{eff}	3			✓	✓
System total active power P	3			✓	✓
System total reactive power Q	3			✓	✓
System total apparent power S	3			✓	✓
System total reactive distortion power D	3			✓	✓
System total Active power of the fundamental oscillation P ₁	3			✓	✓
System total Reactive power of the fundamental oscillation Q ₁	3			✓	✓
System total Power factor PF	3		✓	✓	✓
System total Fundamental oscillation power factor / Cos(Phi) PF ₁	3		✓	✓	✓
Energy (3 tariffs, consisting of 1 main tariff and 2 ancillary tariffs)					
Active energy W _P	3 x 3 tariffs			System total	
Active energy W _P consumed	3 x 3 tariffs			System total	
Active energy W _P delivered	3 x 3 tariffs			System total	
Reactive energy W _Q	3 x 3 tariffs			System total	
Reactive energy consumed W _Q inductive	3 x 3 tariffs			System total	
Reactive energy consumed W _Q capacitive	3 x 3 tariffs			System total	
Reactive energy delivered W _Q inductive	3 x 3 tariffs			System total	
Reactive energy delivered W _Q capacitive	3 x 3 tariffs			System total	
Apparent energy W _S	3 x 3 tariffs			System total	

Table: Overview of the measured values recorded by the device.

For more information on the measured values, see section „21.2 Performance characteristics of functions“ on page 142.

4. Structure of the device

4.1 Front panel and display

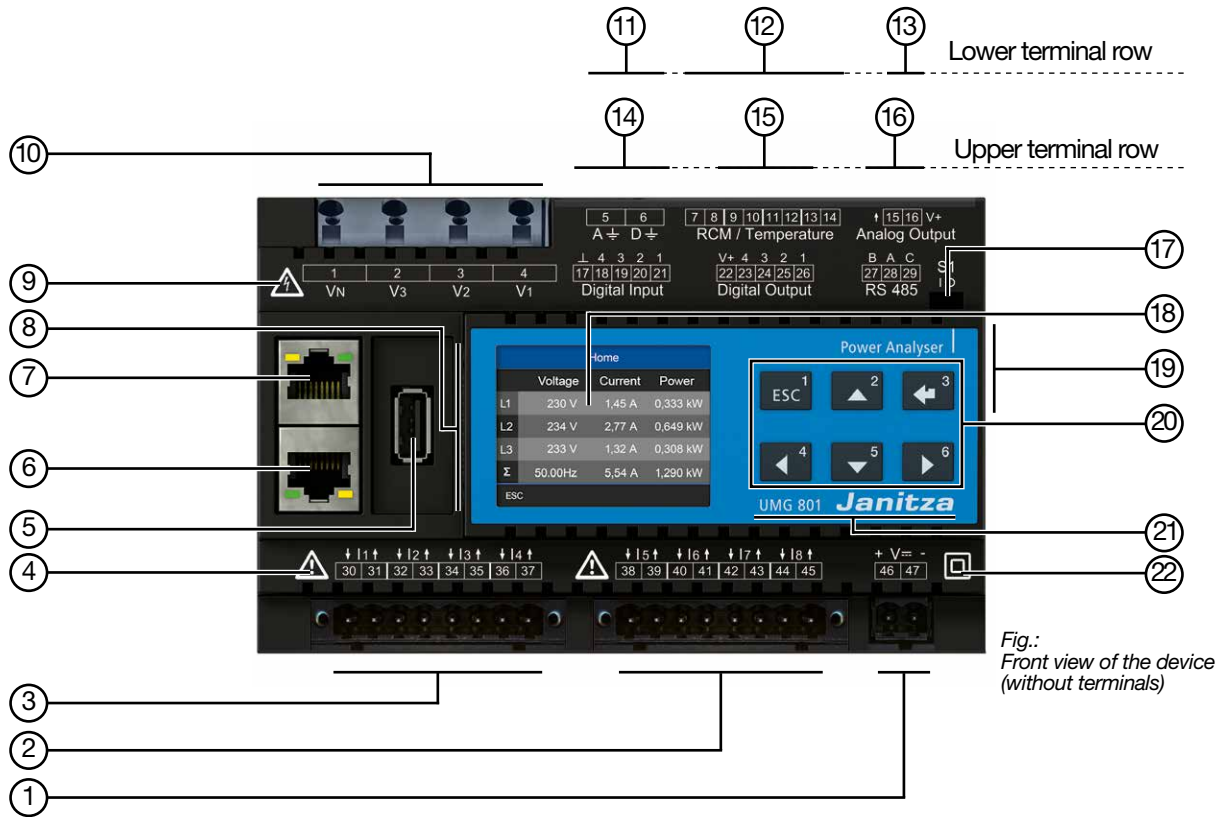

Fig.: Front view of the device (without terminals)

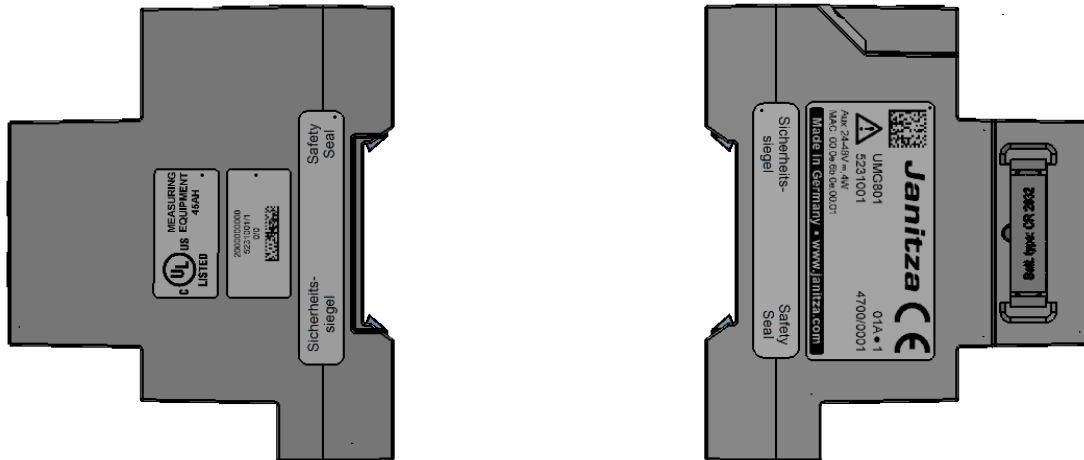

Fig.: Front panel - 3D (without terminals)

Item	Function/Designation
1	Supply voltage connection.
2	Current measurement inputs I5 to I8 for · Measurement of an additional system (L1, L2, L3, N). · Single channel measurements.
3	Current measurement inputs I1 to I4 for · Measurement of one system (L1, L2, L3, N). · Single channel measurements.
4	“Hazard symbol” – General warning symbol. Be certain to observe the warning notices applied to the device and shown in the usage information in order to avoid possible injury or even death.
5	USB interface (2.0), type A (e.g. connection for the RD 96 external display - optional).
6	Ethernet interface (RJ45) - with autonomous network communication (Ethernet B).
7	Ethernet interface (RJ45) - with autonomous network communication (Ethernet A).
8	Battery compartment (type Lithium CR2032, 3 V, UL 1642 approved).
9	“Hazard symbol” – Warning symbol indicating an electrical hazard. Be certain to observe the warning notices applied to the device and shown in the documentation in order to avoid possible injury or even death.
10	Voltage measurement inputs V_1 , V_2 , V_3 and V_N .
11	Connections for functional earth.
12	Connections for residual current (RCM) and temperature measurement, mA current measuring channels.
13	1 analog output.
14	4 digital inputs.
15	4 digital outputs.
16	RS-485 interface.
17	DIP switch for RS-485 termination - see section „9.2.3 Bus structure (bus segment)“ on page 58.
18	Device display.
19	Rear of the device: JanBus interface (bus connector connection, module connection).
20	Function buttons 1 - 6 (see section „10.2 Function buttons“ on page 62).
21	Device designation and manufacturer logo.
22	Symbol “Protection class” - Protection class II (reinforced or double insulation) according to IEC 60536 (VDE 0106, Part 1).

Tab.: Device structure - Connections and controls

4.2 Side views (device without terminals)



4.3 Bottom view (device without terminals)

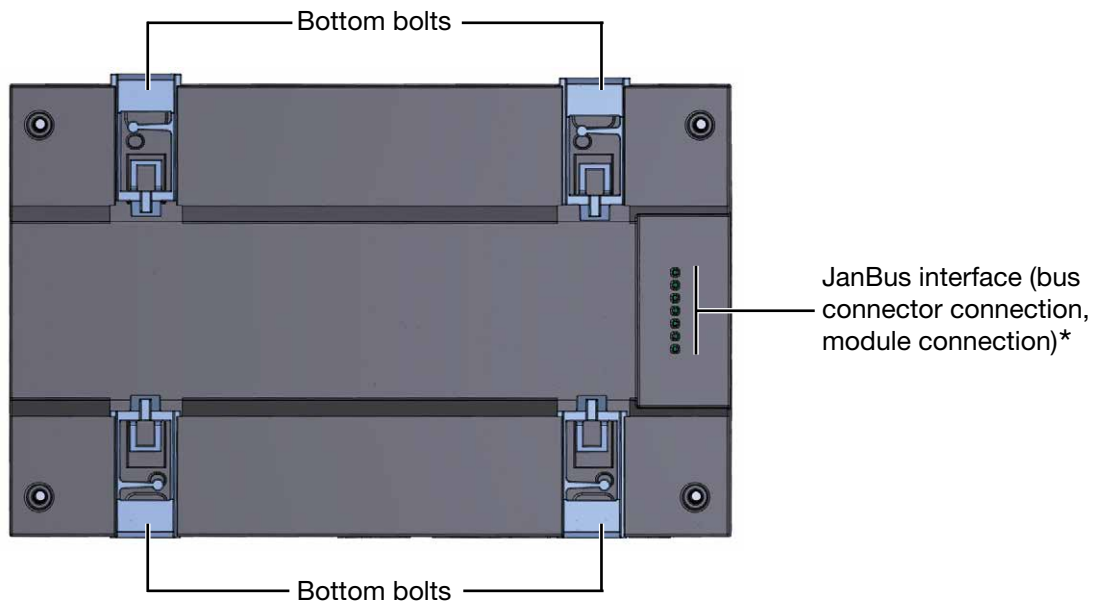

i INFORMATION

* When the device is delivered, the bus connectors are already plugged into the JanBus interface!

4.4 Identification of the device (rating plate)

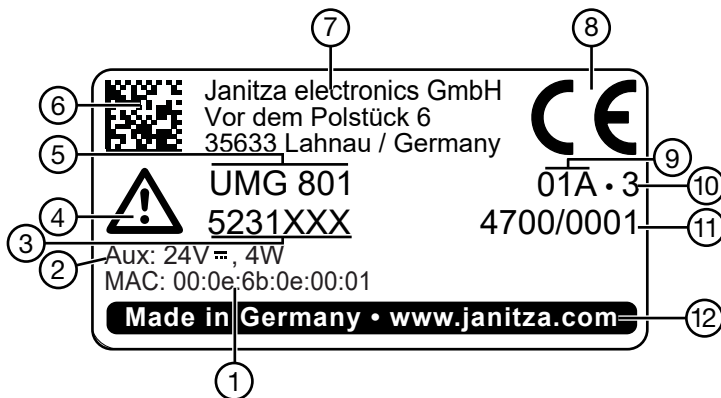

Item	Designation	Description
1	MAC address	Unique identification of the device in a computer network.
2	Operational data	Supply voltage and maximum power consumption.
3	Part number of the measurement device	Manufacturer's part number - marking for traceability (Actual part number may differ from illustration - see delivery note)
4	Symbol for "Danger sign"	General warning symbol. Be certain to observe the warning notices applied to the device and shown in the usage information in order to avoid possible injury or even death.
5	Device type	Device designation.
6	Data matrix code	Coded manufacturer data.
7	Manufacturer's address	Full address of the device manufacturer.
8	CE conformity marking	See Sect. "3.5 Conformity declaration" on p. 20.
9	Manufacturer-specific data	Manufacturer data.
10	Hardware version	Hardware version of the device.
11	Type/serial number	Number for identification of the device.
12	Designation of origin/web address	Country of origin and manufacturer's web address.

Tab.: Device identification, rating plate

5. Mounting

5.1 Installation location

DANGER

Danger of electric shock!

Electric shocks lead to serious injuries, including death.

- Disconnect your system from the power supply before mounting and connecting the device!
- Secure it against being switched on!
- Check to be sure it is de-energized!
- Ground and short circuit!
- Cover or block off adjacent live parts!
- The installation must only be carried out by qualified personnel with electrical training!

Mount the measurement device in switchboard cabinets or small distribution boards according to DIN 43880 on a 35 mm DIN rail (for type, see Sect. "21. Technical specifications" on p. 134) according to DIN EN 60715. The mounting orientation is arbitrary.

ATTENTION

Material damage due to improper handling or disregard of the installation instructions!

Incorrect mounting of the UMG 801 can destroy the contacts of the bus connector (JanBus interface)!

- **Use suitable DIN rails according to DIN EN 60715 for mounting the meter! For suitable DIN rail types, see section „21. Technical specifications“ on page 134.**
- **Before you begin mounting and wiring your UMG 801 on the DIN rail, plug the bus connector into the sockets on the back of the device if this has not yet been done!**
- **Never:**
 - touch or manipulate the contacts of the bus connector!
 - force the contacts into the bus connector sockets!

ATTENTION

Material damage due to disregard of the installation instructions!

Disregard of the installation instructions can damage or destroy your device.

- Provide adequate air circulation in your installation environment and, as needed, cooling when the temperatures are high.

ATTENTION

Improper handling or handling them too roughly can destroy your devices, modules and components!

Contacts, bottom bolts and retaining brackets can be damaged or broken off during mounting or dismantling.

- **Never use force to mount or dismount devices, modules and components! Never tear devices, modules or components off of the DIN rail.**
- **When dismantling devices, modules and components, remove the wiring beforehand (e.g. cables, current transformers, etc.).**
- **Carefully unlock the bottom bolts and retaining brackets of the devices, modules and components with a screwdriver!**
- **Never touch or manipulate contacts! Protect the contacts during handling, transport and storage!**
- **Observe related usage information on the devices, modules and components!**

5.2 Bus connector

i INFORMATION

The measurement device is supplied with the appropriate bus connectors. Please also note the following before setting up a measurement device and module topology

- Mount the bus connector!
- The usage information of the integrated modules and components

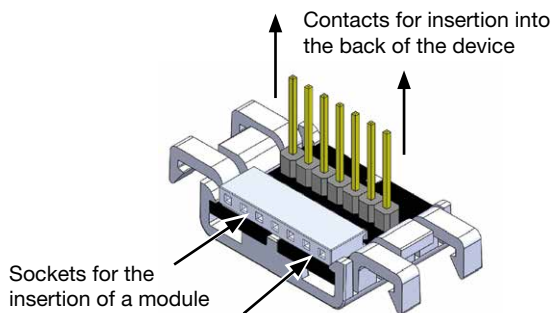

Fig.: Bus connector of the UMG 801 (scope of delivery)

5.3 DIN rail mounting of the device

i INFORMATION

Observe the dimensions of the terminals used on the connections of the device for DIN rail mounting! Provide sufficient free space for the wiring!

Proceed as follows for the DIN rail mounting of the UMG 801:

1. Check the installation of the bus connector (included in delivery, pre-assembled) on the back of your device. If not already done, plug the contacts of the bus connector into the sockets on the back of the measurement device (see Figures 1 - 3).

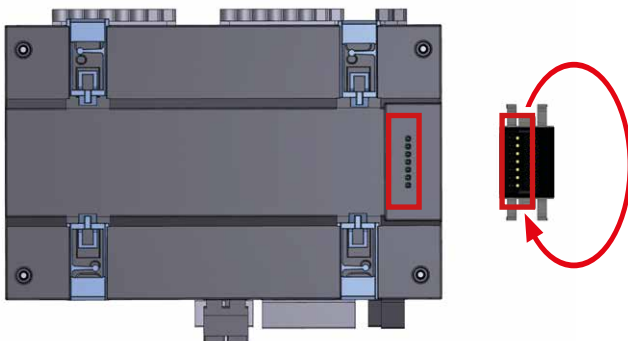

Fig. 1 - Installing the bus connector:
Back of device and front of bus connector

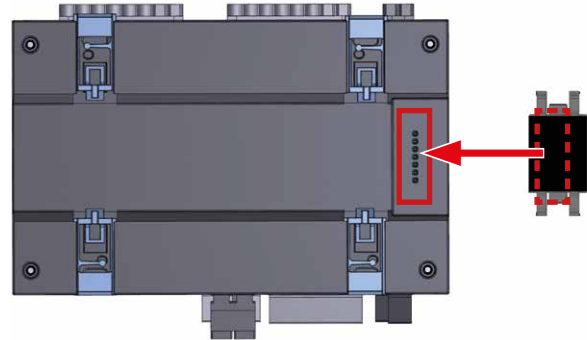

Fig. 2 - Installing the bus connector:
Back of device and bus connector

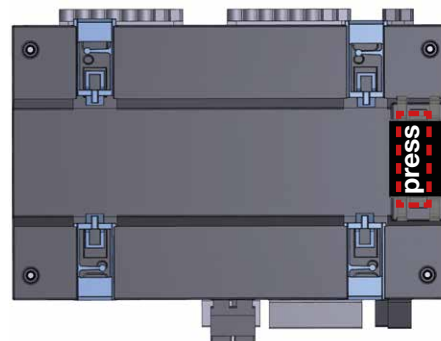

Fig. 3 - Installing the bus connector:
Back of device with bus connector installed

2. Push in the bottom bolt of the clamping mechanism.

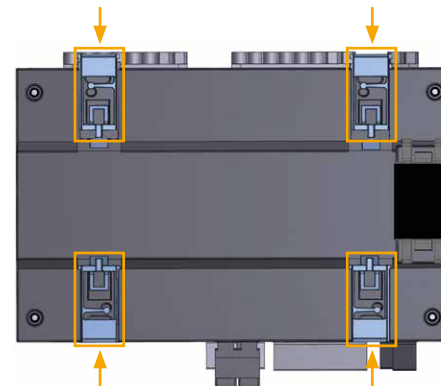

Fig. 4 - Pushing in the bottom bolts:
Back of device with bus connector installed and bottom bolts pressed in.

3. Set up the measurement device with the bus connector on the DIN rail vertically and press until the 4 bottom bolts engage.

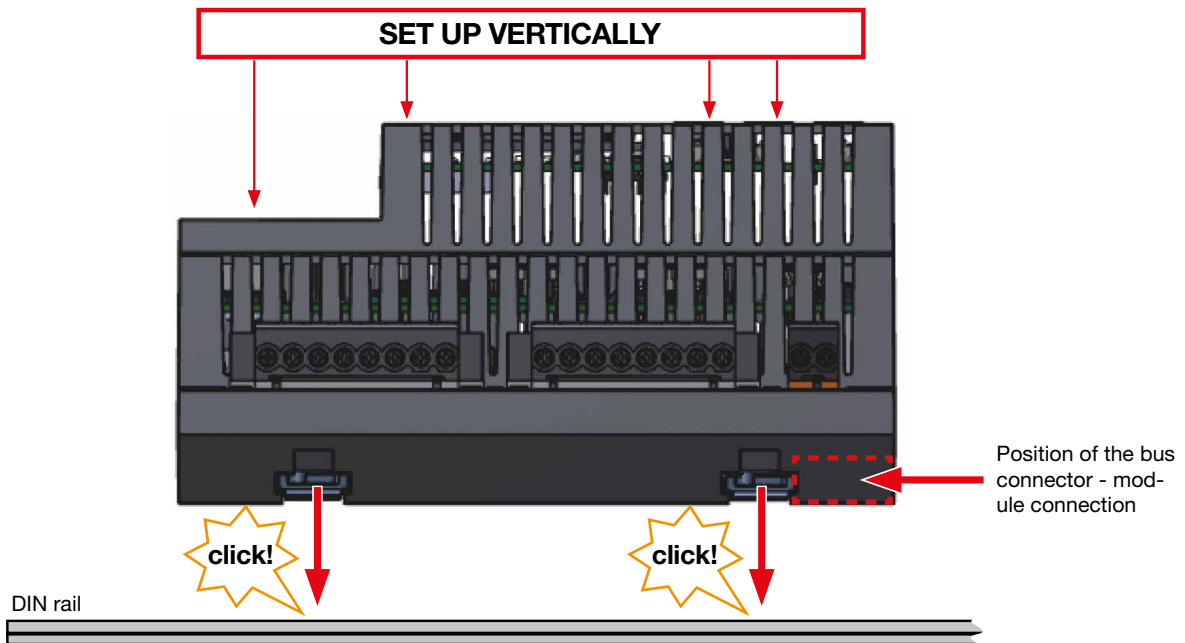

Fig. 5: Device with terminals and bus connectors on DIN rail according to DIN EN 60715 (for DIN rail types, see technical data)



Fig. 5: Device with terminals on DIN rail according to DIN EN 60715 (front view)

4. Check the fit of your measurement device and mount end brackets. Also mount end brackets at all ends of measurement device and module series!
5. Wire your measurement device in compliance with the enclosed installation manual.

The maximum number of modules that can be connected to a UMG 801 (basic device) via the bus connectors can be found in the user manual for the respective module.

6. Grid systems

Suitable grid systems and maximum rated voltages according to DIN EN 61010-1/A1:

Three-phase 4-conductor systems with grounded neutral conductor	
IEC	U_{L-N} / U_{L-L} : 480 V _{LN} / 830 V _{LL}
UL	U_{L-N} / U_{L-L} : 347 V _{LN} / 600 V _{LL}

Three-phase 4-conductor systems with ungrounded neutral conductor (IT networks)	
IEC	U_{L-L} : 690 V _{LL}
UL	U_{L-L} : 600 V _{LL}

Three-phase 3-conductor systems ungrounded	
IEC	U_{L-L} : 690 V _{LL}
UL	U_{L-L} : 600 V _{LL}

Three-phase 3-conductor systems with grounded phase	
IEC	U_{L-L} : 830 V _{LL}
UL	U_{L-L} : 600 V _{LL}

Range of application of the meter:

- 3 and 4-conductor networks (TN, TT and IT networks).
- Industrial areas.

⚠ WARNING

Risk of injury due to electrical voltage!

Rated surge voltages above the permitted over-voltage category can damage the insulation in the device. This impairs the safety of the device. This can result in serious injury or death.

- **Only use the device in environments which comply with the permissible rated surge voltage.**
- **Observe the limit values specified in the user manual and on the rating plate.**

i INFORMATION

Functional earth

- **Connection D** in TN, TT and IT networks must always be connected.
- **Connection A** only connect in TN and TT networks (**not in IT networks**).

7. Installation

Use the meter for voltage measurement in TN, TT and IT networks with the approved overvoltage category of 1000 V CAT III according to IEC and 600 V CAT III according to UL (rated surge voltage 8 kV).

⚠ WARNING

Risk of injury due to electrical voltage!
Do **not** short-circuit secondary connections of voltage transformers! This can result in serious injury or death.

- **Connect voltage transformers according to their documentation!**
- **Check your installation!**

⚠ WARNING

Disregard of the connection conditions of the transformers to Janitza measurement devices or their components can lead to injuries or even death or to material damage!

- Do not use Janitza measurement devices or components for critical switching, control or protection applications (protective relays)! It is not permitted to use measured values or measurement device outputs for critical applications!
- For Janitza measurement devices and their components use **only "Transformers for measurement purposes"** which are suitable for the energy monitoring of your system. Do **not** use **"Transformers for protection purposes"**!
- Observe the information, regulations and limit values in the usage information on **"Transformers for measuring purposes"**, including during testing and commissioning of the Janitza measurement device, the Janitza component and your system.

7.1 Nominal voltages

Nominal network voltages in the three-phase 4-conductor network with grounded neutral conductor suitable for the measuring inputs of your meter:

U_{L-N} / U_{L-L}	
66 V / 115 V	
120 V / 208 V	
127 V / 220 V	
220 V / 380 V	
230 V / 400 V	
240 V / 415 V	
260 V / 440 V	
277 V / 480 V	
347 V / 600 V	Maximum nominal voltage of the network according to UL
400 V / 690 V	
417 V / 720 V	
480 V / 830 V	Maximum nominal voltage of the network according to IEC

Tab.: Nominal network voltages suitable for measurement inputs acc. to EN 60664-1:2003

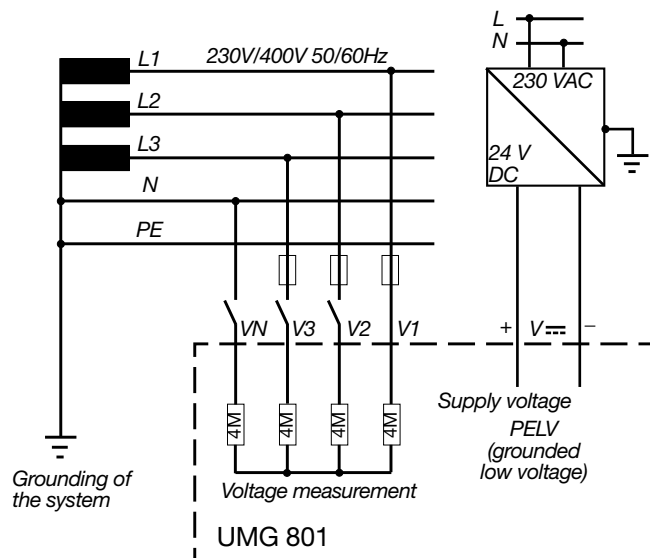

Three-phase 4-conductor network with grounded neutral conductor

i INFORMATION

Further details on the technical data can be found in the chapter „21. Technical specifications“ on page 134.

7.2 Circuit breaker

When installing in a building, provide a suitable circuit breaker for the supply voltage in order to disconnect your system and thus your device from the supply of power.

- Install the circuit breaker of your system or device in such a way that it is easily accessible by the user.
- Mark the switch as an isolation device for your system or device.

7.3 Supply voltage

⚠ WARNING

Risk of injury due to electrical voltage!

Severe bodily injury or death can result from:

- Touching bare or stripped leads that are energized.
- Device inputs that pose a hazard when touched.

Before mounting and connecting the device, take the following steps on your system:

- Disconnect the supply of power!
- Secure it against being switched on!
- Check to be sure it is de-energized!
- Ground and short circuit!
- Cover or block off adjacent live parts!

A supply voltage is required to operate the device. The type and level of the supply voltage for your device can be found on the rating plate.

The supply voltage is connected via plug-in terminals (scope of delivery) on the front of the device.

Before applying the supply voltage, make sure that the voltage and frequency match the specifications on the rating plate.

After connecting the supply voltage, the display becomes active.

ⓘ INFORMATION

Note that the device requires an initialization phase (boot time) at startup!

If no display appears, check:

- The connection of your device.
- The supply voltage.

ⓘ INFORMATION

The fuse is a line protection, not a device protection!

ATTENTION

Material damage due to disregard of the connection instructions!

Disregard of the connection instructions or exceeding the permissible voltage range can damage or destroy your device.

Before connecting the device to the supply voltage, please note:

- Voltage and frequency must correspond to the specifications on the rating plate!
- Observe the limit values as described (see section „21. Technical specifications“ on page 134)!
- In the building installation, secure the supply voltage with a UL/IEC listed line circuit breaker/fuse!
- Observe the following for the isolation device:
 - Install it close to the device and easily accessible for the user.
 - Mark it for the respective device.
- Do not tap the supply voltage from the voltage transformers.
- Provide a fuse for the neutral conductor if the neutral conductor terminal of the source is not grounded.

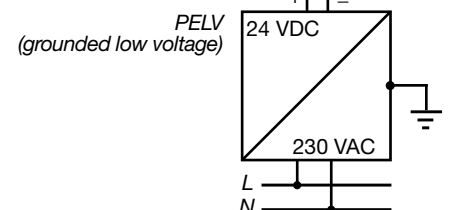

7.4 Voltage measurement

The device has 4 voltage measurement inputs and is suitable for various connection variants.

⚠ WARNING

Risk of injury or damage to the device due to electrical voltage and improper connection!
 Failure to comply with the connection conditions for the voltage measurement inputs can result in damage to the device or serious injury, including death. Therefore, please observe the following:

- **Switch off your installation before commencing work! Secure it against being switched on! Check to be sure it is de-energized! Ground and short circuit! Cover or block off adjacent live parts!**
- **Concerning the voltage measurement inputs:**
 - Do not apply DC voltage to them.
 - Equip the voltage measurement inputs with a suitable, marked fuse and isolation device (alternatively: line circuit breaker) located nearby.
 - The voltage measurement inputs are dangerous to touch.
- **Connect voltages that exceed the permissible nominal network voltages via a voltage transformer.**
- **Measured voltages and currents must originate from the same network.**

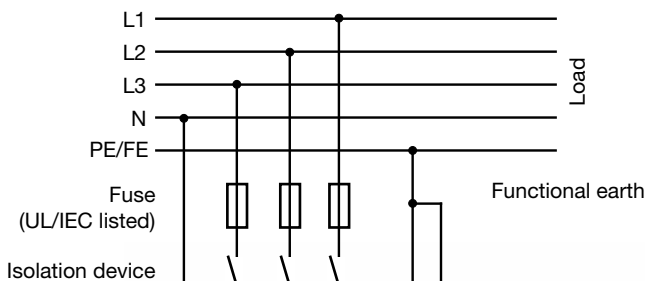

Fig. Connection example for "voltage measurement". PELV

i INFORMATION

As an alternative to the fuse and isolation device, you can use a line circuit breaker.

i INFORMATION

The functional earthing is a functional part and essential for the regular operation of the electrical system.

7.4.1 Overvoltage

The voltage measurement inputs are for measurements in low-voltage networks in which nominal voltages occur, as described in the chapter „21. Technical specifications“ on page 134. Information on the rated surge voltages and overvoltage categories can also be found in the technical data.

7.4.2 Mains frequency

The device:

- Requires the mains frequency for the measurement and calculation of measured values.
- Is suitable for measurement in networks in which the fundamental oscillation of the voltage is in the range from 40 Hz to 70 Hz.
- Requires a voltage L1-N of greater than 10 V_{eff} for the automatic determination of the mains frequency at the voltage measurement input V1.
- Calculates the sampling frequency of the voltage and current measurement inputs from the mains frequency.

i INFORMATION

The device only determines measured values if a voltage L1-N of greater than 10 V_{eff} (4-conductor measurement) or a voltage L1-L2 of greater than 18 V_{eff} (3-conductor measurement) is applied to the voltage measurement input V1.

Use line protection with IEC/UL approval (1 - 10 A, tripping characteristic B) as an overcurrent protective device for the voltage measurements.

7.4.3 Connection variants for voltage measurement

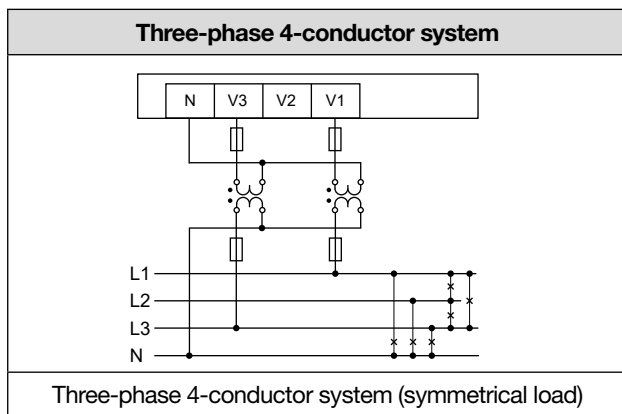
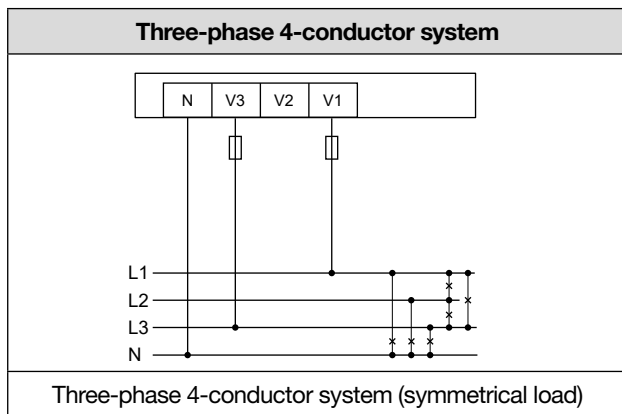
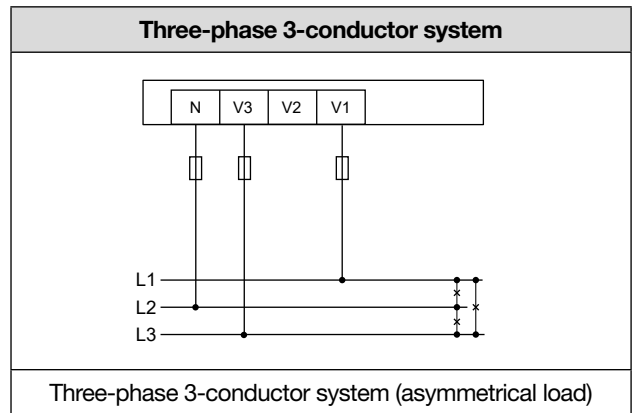
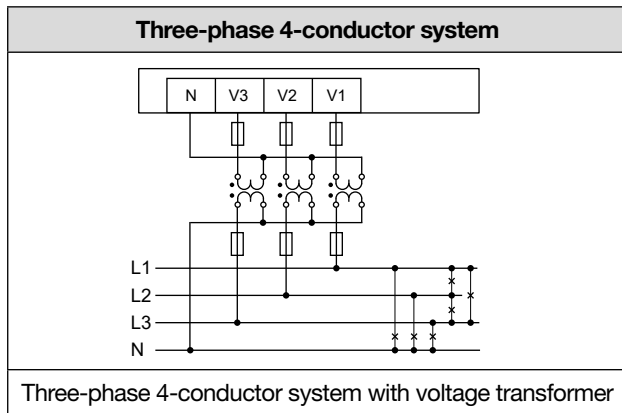
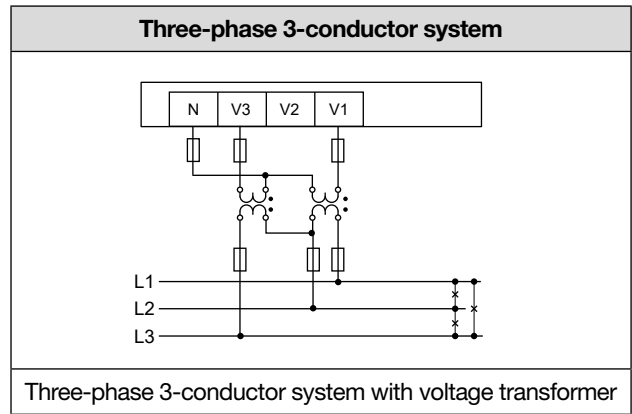
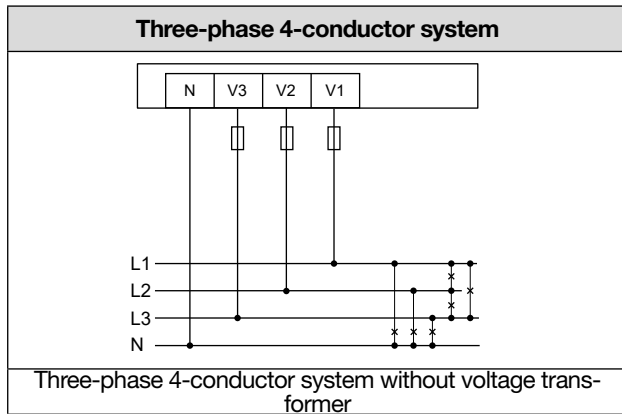

ⓘ INFORMATION

- If the measuring range is exceeded, a warning message appears in the measurement display (see section „20.1 Overrange“ on page 132).
- For a PE/N measurement, connect measurement input A as the functional earth. Do not use a green-yellow wire for this, as the conductor has no protective function!

7.5 Current measurement

The device:

- Measures current exclusively via current transformers.
- Permits the connection of current transformers with a transformer ratio of $\dots/1$ A and $\dots/5$ A for current measurement inputs I1 to I8.
- Has a current transformer ratio of 5/5A (I1 to I8) as the default setting.
- Allows mA current measurement via the multi-function channels (terminals 7 to 14) only with suitable current transformers (<40 mA secondary).
- Is modularly expandable up to 92 current measuring channels (see usage information for the current measuring modules).

The current transformers require a basic insulation according to IEC 61010-1:2010 for the nominal voltage of the circuit.

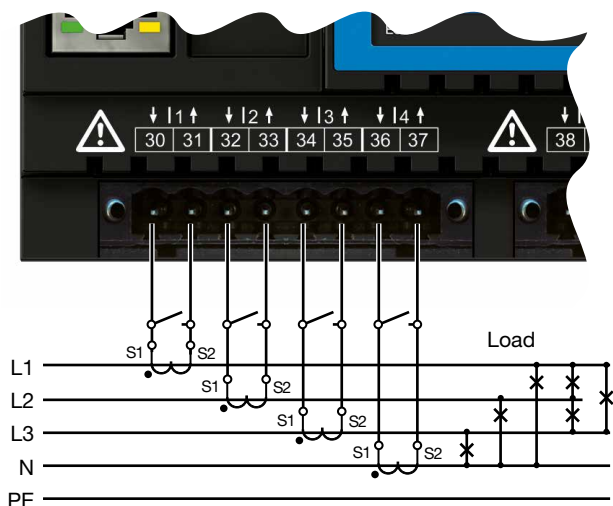

Fig. Connection example for "Current measurement".

ATTENTION

Material damage due to disregard of the connection instructions during current measurement. Failure to comply with the connection requirements of your device can result in the permissible current measurement range being exceeded. This can lead to damage or destruction of your device or your system and thus to material damage!

- **Use current transformers for current measurement! The device only allows current measurement via current transformers!**
- **Observe the connection conditions for the current measurement inputs of your device and the current transformers!**

⚠ WARNING

Risk of injury due to high currents and high electrical voltages!

Severe bodily injury or death can result from:

- Touching bare or stripped leads that are energized.
- Dangerous live current measurement inputs of the device and at the current transformers.

Therefore, please note for your system:

- **Disconnect the supply of power before starting work!**
- **Secure it against being switched on!**
- **Check to be sure it is de-energized!**
- **Ground and short circuit! Use the ground connection points with the ground symbol for grounding!**
- **Cover or block off adjacent live parts!**

⚠ WARNING

Risk of injury due to electrical voltage at current transformers!

Current transformers which are operated exposed on the secondary side can carry hazardous live high voltage peaks which can lead to serious bodily injury or death.

Therefore please abide by the following:

- **Switch off your installation before commencing work! Secure it against being switched on! Check to be sure it is de-energized! Ground and short circuit! Cover or block off adjacent live parts!**
- **Avoid exposed operation of the current transformers.**
- **Short-circuit unloaded current transformers.**
- **Before interrupting the current supply, short circuit the secondary connections of the current transformers.**
- **If there is a test switch which automatically short-circuits the secondary current transformer lines, it is sufficient to set it to the "Test" position, provided that the short-circuiters have been checked beforehand.**
- **Only use current transformers with basic insulation according to IEC 61010-1:2010.**
- **Fix the attached screw terminal to the device with the two screws.**
- **Even current transformers rated as safe for exposed operation are dangerous to touch if they are operated exposed.**

⚠ WARNING

Risk of injury or damage to the device due to electrical voltage and improper connection!

At high measuring currents, temperatures of up to 80 °C (176 °F) can occur at the connections.

Use wiring designed for an operating temperature of up to 80 °C (176 °F)!

7.5.1 Connection variants for current measurement

Current measurement I1 to I4 and I5 to I8

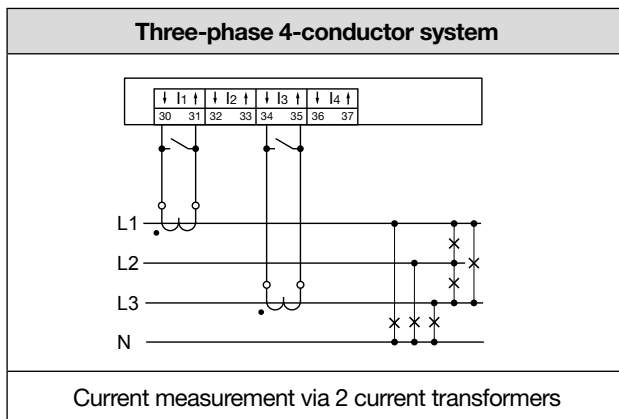
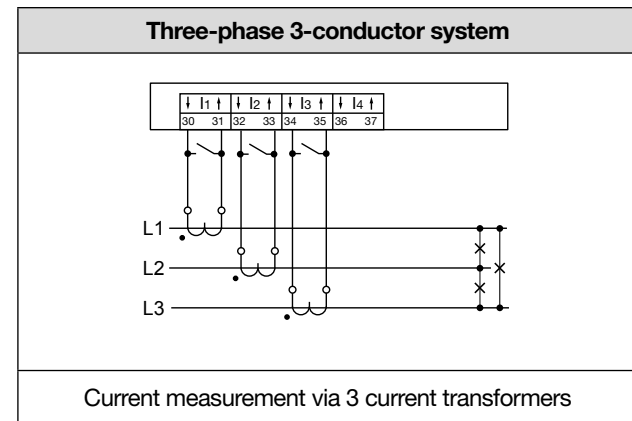
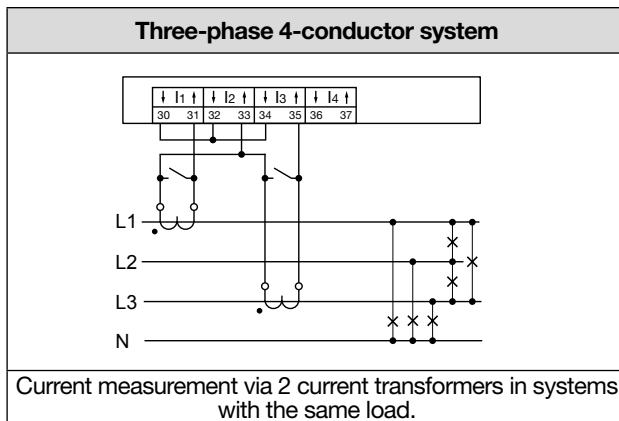
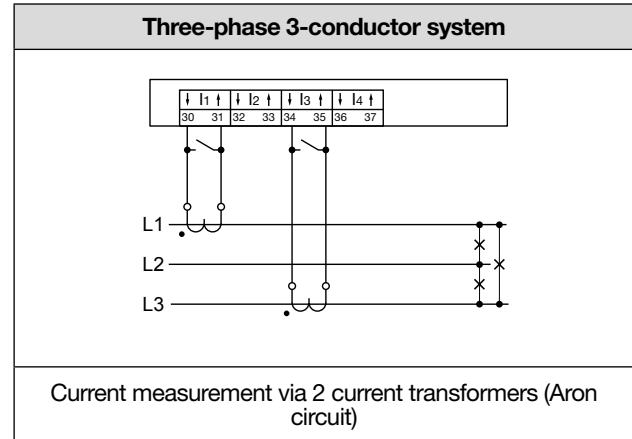
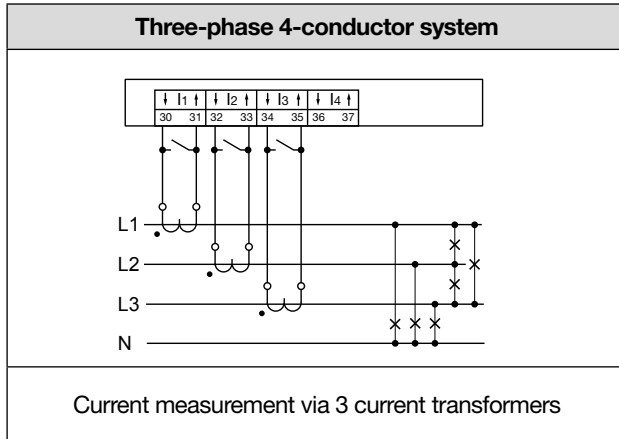

i INFORMATION

You can configure current transformer ratios conveniently via

- The device menu.
- The GridVis® software.

Information on programming the current transformer ratios can be found in section „11.4 Configuring current transformers“ on page 69.

If the measuring range is exceeded, the meter's measurement display for the current shows a warning with the phase indicated (see section „20.1 Overrange“ on page 132).

i INFORMATION

Setting in the GridVis® software:

To activate the Aron circuit in the "Three-phase three-wire system" measurement group mode, select "Calculate" for current channel I2 (L2). This function does not exist for the "Single measurements" measurement group mode.

7.5.2 Summation current measurement

For a summation current measurement via two current transformers, first set their total ratio on the device (for setting the current transformer ratios, see section „11.4 Configuring current transformers“ on page 69).

Example:

The current is measured via two current transformers. Both current transformers have a ratio of 1000/5 A. The summation measurement is carried out with a summation current transformer of 5+5/5 A. Set the device as follows:
 Primary current: 1000 A + 1000 A = **2000 A**
 Secondary current: **5A**

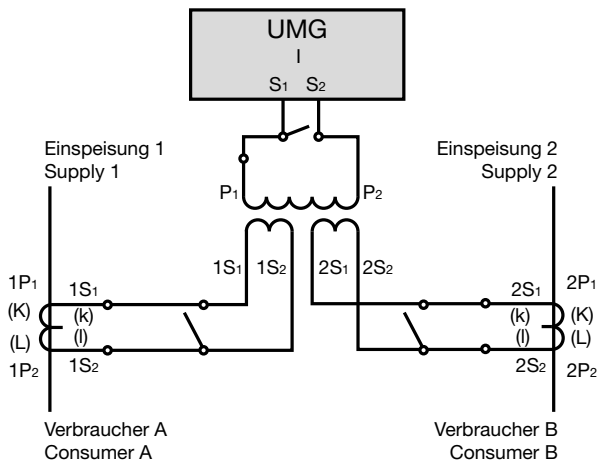

Fig. Example for current measurement via a summation current transformer.

7.5.3 Ammeter

For a current measurement with an additional ammeter, connect the ammeter in series to the UMG:

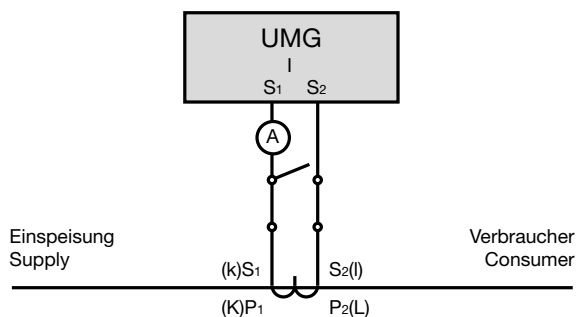

Fig. Example circuit diagram with ammeter in series connection

7.6 Multifunction channels

The multifunction channels 1 to 4 (terminal pairs 7/8, 9/10, 11/12 and 13/14) can optionally serve as connections for the following measurements:

1. Residual current measurement (RCM).
2. Temperature measurement (terminal pair 13/14)
3. Measurement of further current channels (mA range) via suitable current transformers.

Furthermore, the measurement device allows combinations of the 3 mentioned measurements.

Please note:

The prerequisite for the configuration of measurement group 3 as multifunction channels for residual current, temperature or mA current measurement is the measurement group mode **"Single measurements"** in the GridVis® software.

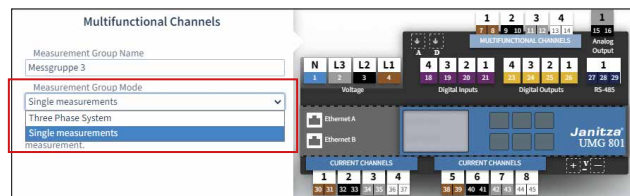

Screenshot of the configuration of the "Single measurements" measurement group mode in the GridVis® software.

i INFORMATION

- All further parameters for the respective functions of the multifunction channels (residual current, temperature or mA current measurement) can be configured in the GridVis® software.
- After changing a measurement of a multifunction channel (e.g. configuration of channel 7/8 from residual current measurement to temperature measurement), **restart the device (menu Configuration -> submenu Reset -> entry Restart)!** With a restart, the device re-initializes the multifunction channels and the respective Modbus profile contains the corresponding measured values.

The above-mentioned measurements using the multifunction channels are explained over the course of the user manual. Further information, e.g. on the "Three-phase system" measurement group mode, can be found in the GridVis® software and in the online help for the software.

7.7 Residual current measurement (RCM)

The measurement device is suitable as a residual current monitoring device (RCM) for monitoring alternating currents, pulsating direct currents and direct currents.

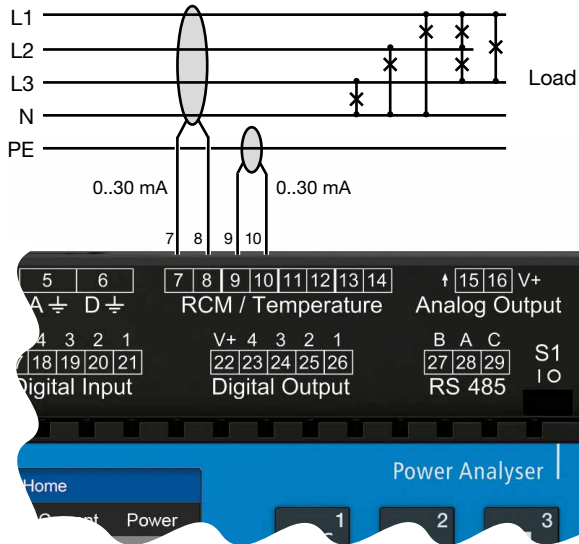



Fig. Connection example "Variant, residual current measurement" via current transformer (Type A).

The meter measures residual currents according to IEC/TR 60755 (2008-01) of:

-  Type A
-  Type B and type B+
(via corresponding current transformers)

Residual current transformers with a nominal current as given in chapter „21. Technical specifications“ on page 134 are suitable for the meter's residual current measurement function.

ATTENTION

Faulty cross currents, incorrect measurements, and even damage to the device and/or your system due to lack of galvanic isolation!

A lack of galvanic isolation of active external current transformers (or other current sensors) on the multifunction channels from the supply voltage of the device can lead to faulty cross currents, incorrect measurements or even damage to your device and/or system.

- Do not take the auxiliary voltage supply of active external current transformers (or other current sensors) on the multifunction channels from the supply voltage of the device! For each active current transformer, use galvanically isolated power supplies (secondary side).
- Do not ground passive current transformers on the multifunction channels! Observe the usage information of the current transformer manufacturer.

Monitoring residual currents in an electrical system via the residual current inputs of the device (terminals 7/8, 9/10, 11/12 and 13/14) allows an alarm management system to be set up with the GridVis® software. This allows the system operator to be alerted before a protective device is triggered, for example.

The measurements in medium and high voltage networks are made via current and voltage transformers.

i INFORMATION

Limit values for warnings and alarms, e.g. for the device or plant operator, can be configured conveniently in the GridVis® software.

In the GridVis® software, you also configure the ratios of the residual current transformers separately for each residual current input.

i INFORMATION

The meter is not an independent protective device against electric shock!

7.7.1 Current direction of the residual current transformers

For residual current measurement with current transformers in AC operation at the measurement inputs, the device does not distinguish between the current directions. Incorrect connection of the residual current transformers in AC operation does not require subsequent rewiring.

INFORMATION

AC operation:

The meter does not distinguish between the current directions of the residual currents.

The residual currents of the grid side or load side are **not** directionally sensitive.

AC/DC operation:

Pay attention to the polarity when using current transformers in AC/DC operation!

See section „7.7.4 Connection examples - Residual current measurement“ on page 43.

WARNING

Risk of injury due to large currents and high electrical voltage on the current transformers!

Current transformers operated while open on the secondary side (high voltage peaks pose a hazard when touched) can result in severe bodily injury or death.

- **Avoid operating the current transformers while open; short circuit the unloaded transformers!**
- **Before interrupting the current supply, short circuit the secondary connections of the current transformers. Switch any test switches that automatically short circuit the secondary lines of the current transformers to the “Test” status (Check the test switch/short circuiting connection beforehand)!**
- **Only use current transformers with basic insulation to IEC 61010-1:2010!**
- **Caution, even current transformers rated as safe for open operation can pose a hazard when touched during operation while open!**
- **Make sure that screw terminals for the current transformer connection on the device are adequately tightened!**
- **Comply with the information and provisions in the documentation of your current transformers!**
- **Ground connections present on the secondary windings of the current transformers must be connected to ground!**
- **Observe the general safety information for handling current transformers and devices with residual current measurement.**

7.7.2 Residual current transformer example

Operating equipment must have reinforced or double insulation from supply circuits!

Example:

A residual current transformer is used to measure on insulated mains wiring in a 300 V CAT III network.

Solution:

Provide basic insulation for 300 V CAT III for the insulation of the network wiring and the insulation of the residual current transformer. This corresponds to a test voltage of 1500 V AC (1 min. duration) for the insulated network wiring and a test voltage of 1500 V AC (1 min. duration) for the residual current transformer.

7.7.3 Important information about the residual current measurement inputs

CAUTION

Risk of injury or damage to the meter/your system due to short circuit!

Inadequate insulation of the operating equipment at the residual current measurement input with respect to the supply circuits can cause voltages at the measurement input which represent a hazard when touched or damage to your device or system.

- **Ensure reinforced or double insulation with respect to the supply circuits.**
- **Isolate residual current measurement inputs galvanically from each other and galvanically from the supply voltage (24 V)!**

INFORMATION

Ratios for the residual current transformer inputs can be configured individually on the meter or via the Grid-Vis® power grid monitoring software.

7.7.4 Connection examples - Residual current measurement

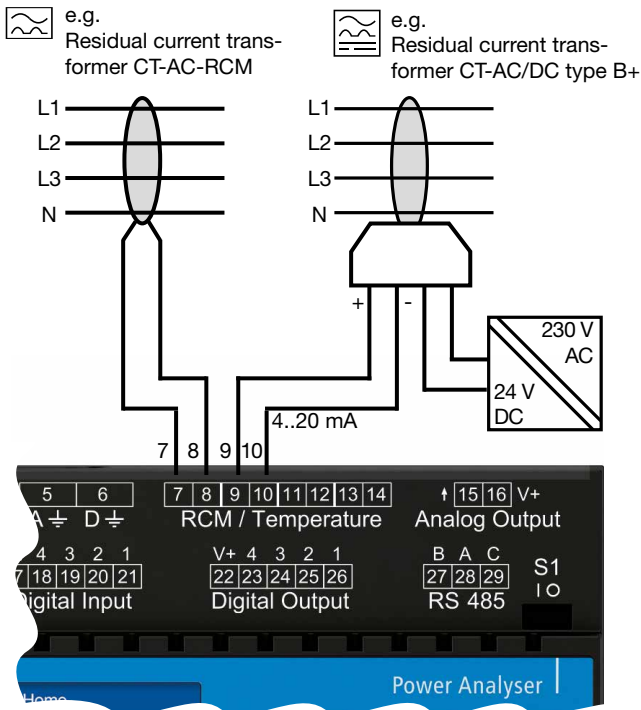

⚠ CAUTION

Risk of injury or damage to the meter/your system due to short circuit!
 Inadequate insulation of the operating equipment at the residual current measurement input with respect to the supply circuits can cause voltages at the measurement input which represent a hazard when touched or damage to your device or system.

- **Ensure reinforced or double insulation with respect to the supply circuits!**
- **Isolate residual current measurement inputs galvanically from each other and galvanically from the supply voltage (24 V)!**

Fig. Connection variant, residual current measurement via current transformer Type A and Type B. (Power supply with $U = 24\text{ VDC}$, residual ripple $< 5\%$, output = 24 W).

i INFORMATION

Pay attention to the polarity when using type CT-AC/DC current transformers!

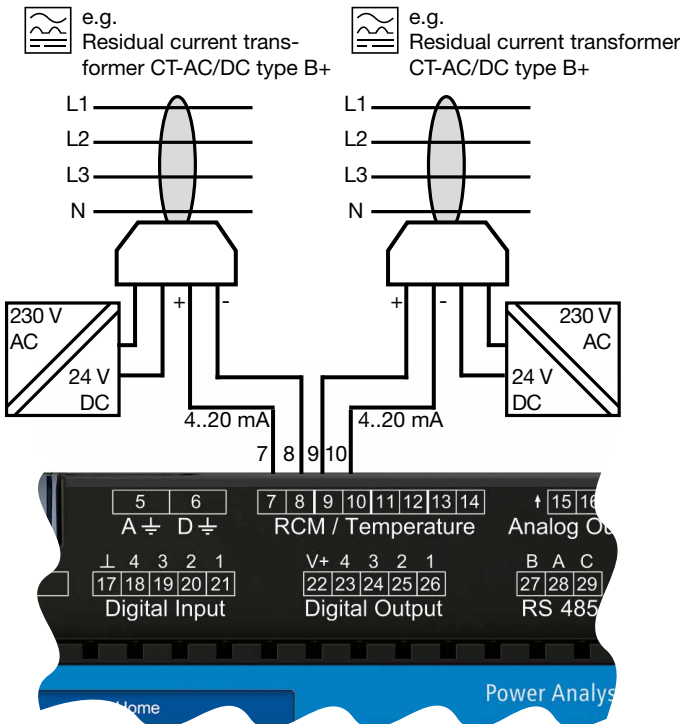

Fig. Connection variant, residual current measurement using a current transformer of Type B. Each residual current transformer of the series CT-AC/DC type B+ RCM requires its own power supply (with $U = 24\text{ VDC}$, residual ripple $< 5\%$, power = 24 W).

i INFORMATION

Galvanically insulate the secondary sides of the power supplies (24 V DC) from each other!

7.7.5 Connection example - Residual current monitoring

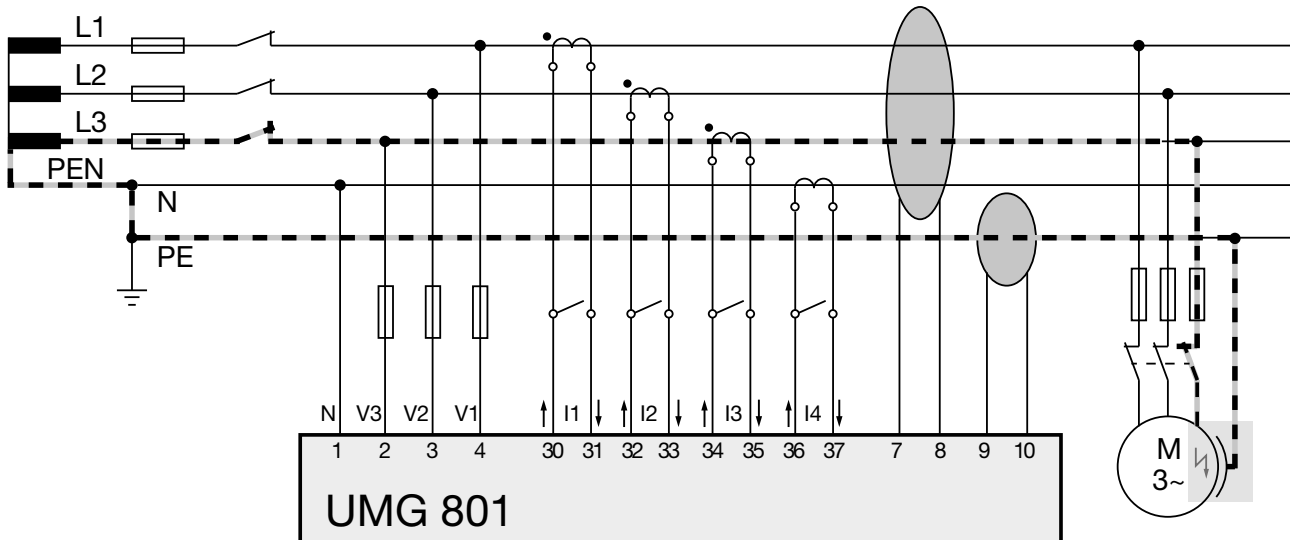

Fig. Connection example UMG 801 with residual current monitoring via 2 multifunction channels (7/8, 9/10) as measurement inputs for the residual currents.

⚠ CAUTION

Risk of injury or damage to the meter/your system due to short circuit!

Inadequate insulation of the operating equipment at the residual current measurement input with respect to the supply circuits can cause voltages at the measurement input which represent a hazard when touched or damage to your device or system.

- **Ensure reinforced or double insulation with respect to the supply circuits!**
- **Isolate residual current measurement inputs galvanically from each other and galvanically from the supply voltage (24 V)!**

7.8 Residual current measurement - limit value calculation

To set and calculate residual current limit values, the device requires parameters that you can set in the **GridVis® software**.

A reference value for the residual current limit value calculation can be applied not only to the current channels and groups of the basic device but also to connected current measuring modules, and it can be configured in the GridVis® software.

The residual current measurement of the UMG 801 and the current measuring modules has 3 types of limit value calculation:

1. Static limit value calculation

A constant limit value is defined. If this limit value is exceeded, a limit violation occurs.

2. Dynamic limit value calculation

In dependence on a reference value, the limit value for violations changes continuously and with it the respective warning.

The respective limit value is calculated from the reference value multiplied by a scaling factor, plus a static offset.

3. Stepwise limit value calculation

In dependence on a reference value, the limit value for violations changes step by step and with it the respective warning. Individual limit values can be defined for up to 10 ascending thresholds of the reference value (power levels). The respective limit values are calculated from the static offset plus the threshold offset of the highest threshold value exceeded by the reference value.

7.8.1 Static limit value calculation

Required parameters:

- Static residual current limit value.
- Minimum time for which the residual current limit value is exceeded (RCM alarm).
- Warning before the static residual current limit value is reached (warning level in %).

$$\text{Residual current limit value} \times \frac{\text{warning level}}{\text{warning limit value}} =$$

Percentage value of the residual current limit value

Example graph

The following example graph explains the residual current measurement with a static limit value calculation:

- Residual current limit value: 300 mA.
- Warning level (in %)

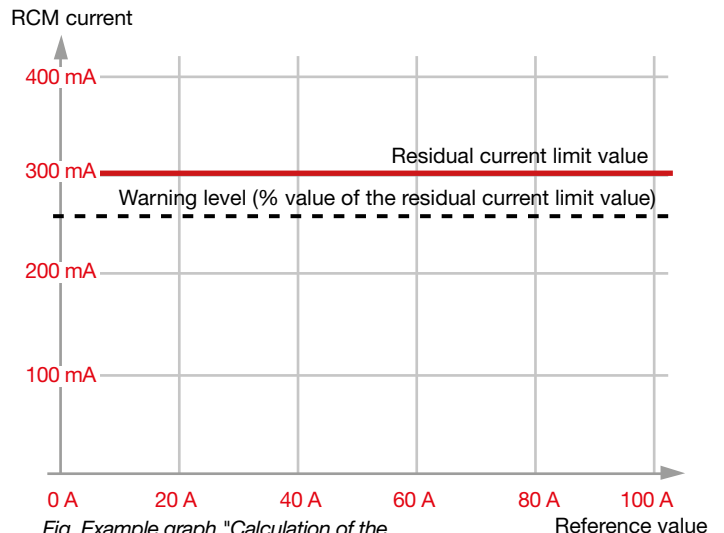

Fig. Example graph "Calculation of the static residual current limit value".

Explanation:

- The static limit value calculation (constant value) is active.
- If a **measured residual current** exceeds the warning level, the device displays a warning.
- If a **measured residual current** exceeds the residual current limit value, the device indicates an overcurrent violation.
- If the **measured residual current** exceeds the residual current limit value for longer than the **minimum exceedance time** (configurable in the GridVis® software), the device triggers an alarm.

7.8.2 Dynamic limit value calculation

Required parameters:

- Minimum time for which the residual current limit value is exceeded (RCM alarm).
- Warning level (percentage value, warning before the limit value is reached).
- Reference value - measured value (selectable from the multifunction channels, the current channels of the basic device or the modules).
- Tolerated residual current (dynamic limit value component in relation to the reference value).
- Offset (static component) of the limit value.

Dynamic limit value

- Is a function of a reference value (measured value).
 - Adjusts the limit value for violations dynamically.
- The dynamic limit value is calculated from:

$$\begin{array}{c} \text{Measured value} \quad \text{Scaling as a reference} \quad \text{Static offset} \\ \text{Reference value} \times \text{scaling factor} + \text{offset} \\ = \\ \text{dyn. Limit value} \end{array}$$

RCM limit value / reference value

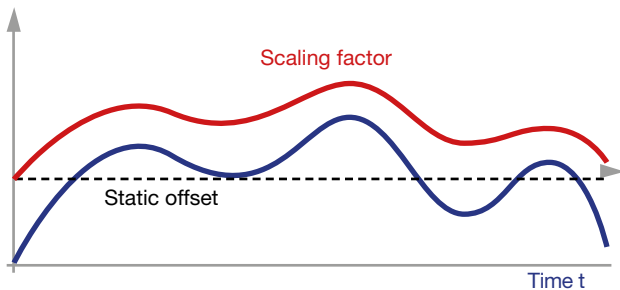

Example graph

The example graph for the dynamic limit value shows the relationship between the residual current limit value and the reference value (e.g. "Power") with the following settings:

- Reference value: Power in kW
- Scaling: 10 mA / kW
- Offset for residual current measurement: 20 mA

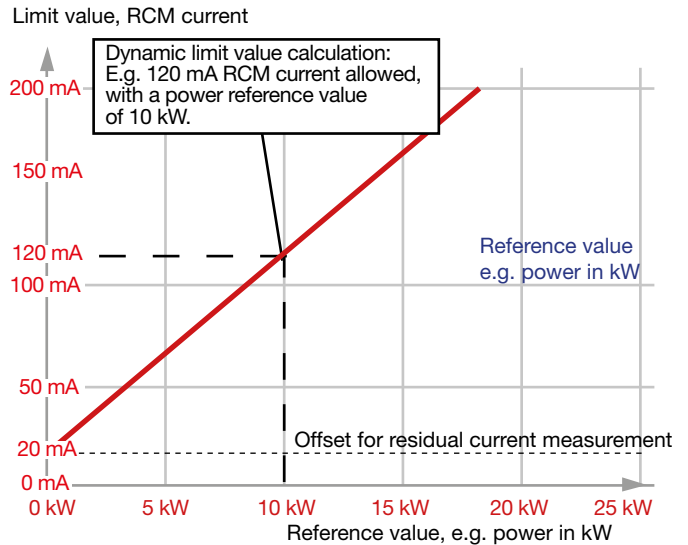

Fig. Example graph, "Calculation of the dynamic residual current limit value".

Warning limit value

The dynamic warning limit value is therefore calculated using the following formula:

$$\begin{array}{c} \% \text{ value} \\ \text{Warning level} \times (\text{reference value} \times \text{scaling factor} + \text{offset}) \\ = \\ \text{Warning limit value} \\ \text{Dynamic limit value calculated by the measurement device} \end{array}$$

7.8.3 Stepwise limit value calculation

Required parameters:

- Reference value (e.g. power in kW).
- Minimum time for which the residual current limit value is exceeded (RCM alarm).
- Warning level (percentage value, warning before the limit value is reached).
- Input of residual current limit values for the respective power levels (steps).
- Offset (static component) of the limit value.

Stepwise limit value

- Is a function of a reference value.
- Adjusts the residual current limit value stepwise in accordance with the power levels and the associated limit value offsets.
- Is calculated from a static offset and the respective limit value offset (the highest threshold value exceeded by the reference value).
- If no power level is configured, the static offset applies.

RCM limit value / reference value

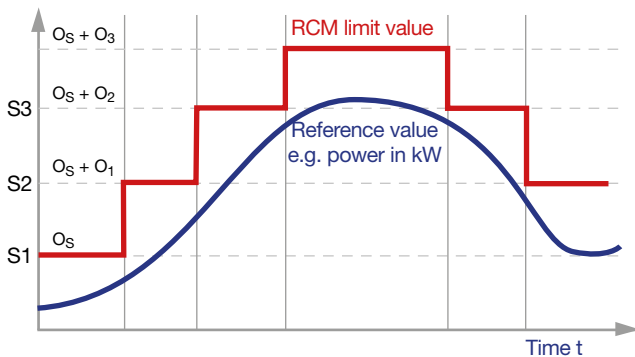

Abbreviation	Description
S1, S2, S3	Thresholds of the stepwise residual current limit values
Os	Static offset
O1, O2, O3	Limit value offsets assigned to the residual current thresholds

Example graph

The example graph shows the stepwise increase of the residual current limit values as a function of the reference value “power” (of the system) with the following power levels (steps):

- Reference value: Power in kW.
- Variable residual current limit value per power level.

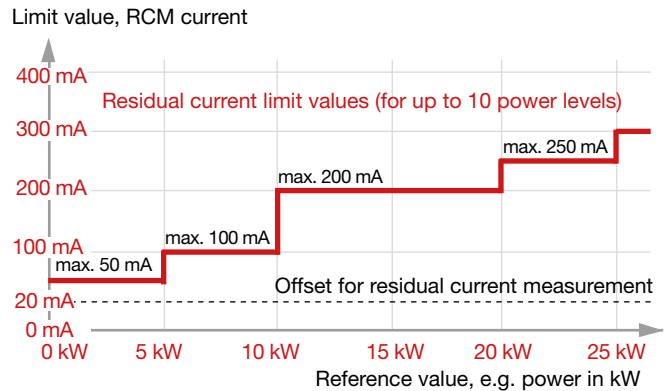
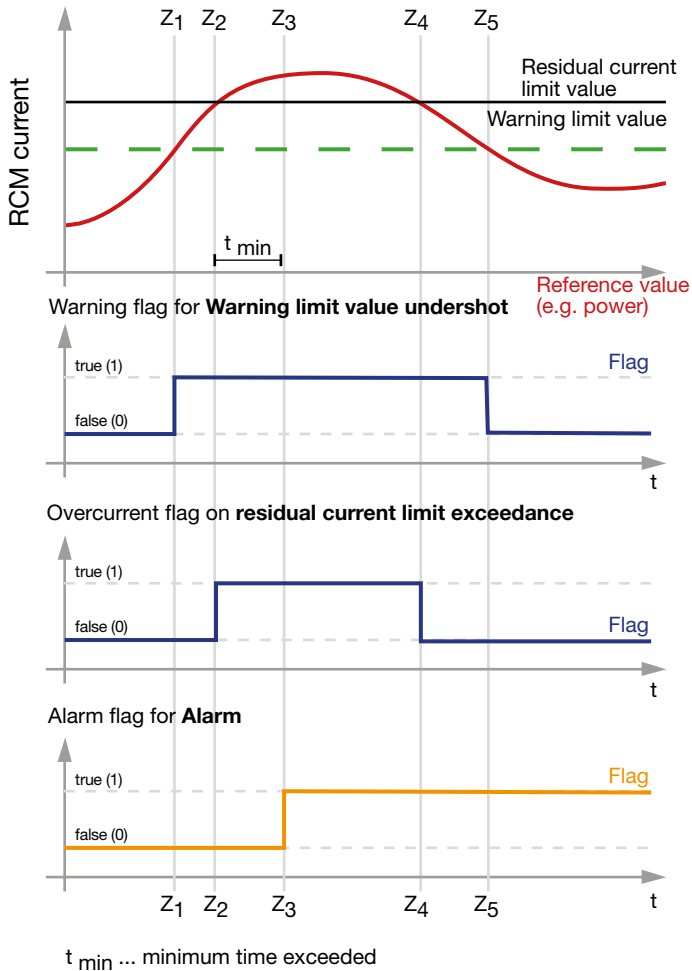

Fig. Example graph, “Calculation of the stepwise residual current limit value”

i INFORMATION

This limit value calculation allows a non-linear configuration of the levels. These non-linear levels make it possible, for example, to configure a lower limit value for higher reference values. This allows machines that have a comparatively low residual current with high power to be configured optimally, for example.

7.8.4 Example: Residual current limit value exceeded



The adjacent graphs explain the 3 events **Warning limit exceeded**, **Residual current limit value exceeded** and **Alarm flag** with the states:

- Warning limit value exceeded at time instant Z₁: Warning flag (=1).
- Residual current limit value undershot at time instant Z₂: Overcurrent flag (=1).
- Residual current limit value exceeded beyond the **minimum duration of exceedance t_{min}** at time instant Z₃: Alarm flag (=1).
- Residual current limit value undershot at time Z₄: The device sets the overcurrent flag (=0).
- Warning limit value undershot at time Z₅: The device sets the warning flag (=0).
- The alarm flag remains set until manual acknowledgment.

i INFORMATION

- The device has an alarm lead time which is used to ensure that the device does **not** trigger an alarm in the case of minor (short) violations of the residual current limit value.
- Limit values for alarms and warnings, e.g. for the device or system operator, can be conveniently configured in the **GridVis**® software.

7.8.5 Activating cable break detection (failure monitoring) RCM for the multifunction channels.

The device has a “cable break detection” (failure monitoring) function via the **GridVis® /OPC-UA** software. In this case, the device checks the connections to the residual current transformers at the measurement inputs (multifunction channels).

The cable break detection (failure monitoring) function can be activated in the **GridVis®** software.

INFORMATION

The cable break detection to monitor the current transformer connections only works with passive current transformers (AC) and current transformers with a 4-20 mA secondary output.

7.9 Temperature measurement

As already described in Sect. “7.6 Multifunction channels” on p. 40, the terminal pairs 7/8, 9/10, 11/12 and 13/14 serve as optional connections for a temperature measurement.

The measured values of the connections declared as temperature inputs are obtained by determining the average value from accumulated resistance values. The meter calculates the temperature value from the average value.

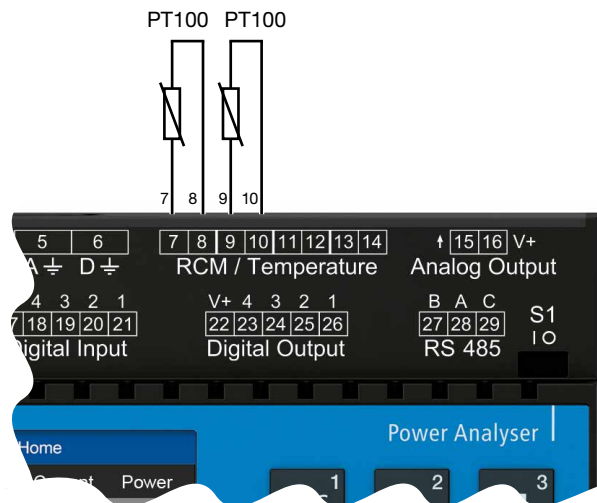

Fig. Connection example “2x temperature measurement” via PT100.

The following temperature sensors are suitable for temperature measurements:

- KTY83
- KTY84
- PT100
- PT1000

Example of temperature sensor:

A temperature sensor is to measure near uninsulated power lines in a 300 V CAT III network.

Solution:

Use reinforced or doubled insulation for the temperature sensor for the 300V CAT III network! This corresponds to a test voltage of 3000 V AC (1 min. duration) for the temperature sensor.

i INFORMATION

You must configure the temperature measurement function in the GridVis® software (see Sect. “11.6 Temperature measurement configuration” on p. 71).

ATTENTION

Damage to the meter and/or your system due to a short circuit!

Inadequate insulation of the operating equipment (e.g. the temperature sensor) at the temperature measurement inputs with respect to the supply circuits can cause damage to your meter and/or your system.

- **Ensure a reinforced or double insulation of your operating equipment with respect to the supply circuits!**
- **Use shielded lines to connect the temperature sensor!**
- **Do not exceed a total load of 4 kΩ (temperature sensor and cable)!**

8. Communication via the Ethernet interfaces

8.1 Functions of the Ethernet interfaces

ATTENTION

Material damage due to security vulnerabilities in programs, IT networks and protocols.

Security vulnerabilities can lead to data misuse and faults and even the standstill of your IT infrastructure.

To protect your IT system, network, data communications and measurement devices:

- Inform your network administrator and/or IT representative.
- Always keep the meter firmware up to date and protect the communication to the meter with an external firewall. Close unused ports.
- Take protective measures against viruses and cyber attacks from the Internet, e.g. through firewall solutions, security updates and virus protection programs.
- Eliminate security vulnerabilities and update or renew existing protection for your IT infrastructure.

ATTENTION

Material damage due to incorrect network settings.

Incorrect network settings can cause faults in the IT network!

Consult your network administrator for the correct network settings for your device.

The measurement device has two Ethernet interfaces (A and B) for communication in Ethernet networks. There are 2 options to integrate the measurement device into Ethernet networks:

1. **Measurement device integration in a network with additional switch function (switched mode).** The measurement device is automatically assigned an IP address by a DHCP server in an IT network via Ethernet interface A, for example. Ethernet interface B has a switch function via which further devices (hardware components) can be connected in series. The measurement device also allows the reverse use of the Ethernet interfaces (e.g. "B" for the IP address from a network and "A" for further devices)!
2. **Measurement device integration in 2 different networks (dedicated mode).**

The Ethernet interfaces A and B of the measurement device are each assigned different IP addresses by 2 different networks.

i INFORMATION

For the configuration of the IP addresses on the meter, see Sect. "11.2 Configuring Ethernet (TCP/IP)" on p. 66.

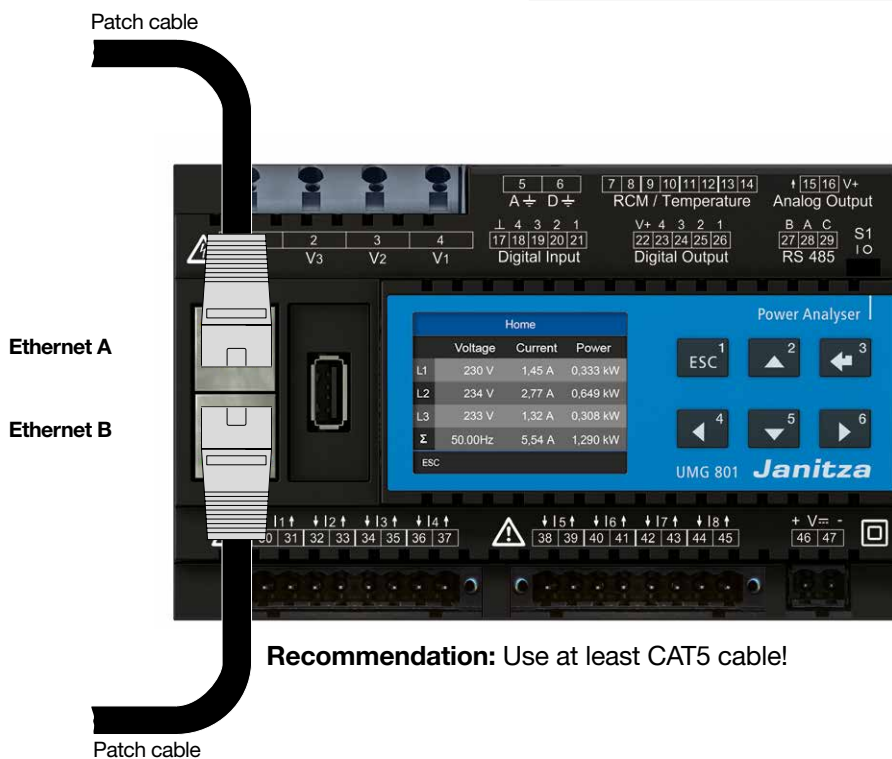

Fig.: UMG 801 with Ethernet interfaces A and B

i INFORMATION

- The switched and dedicated modes of the measurement device can be configured in the GridVis® software.
- The default setting of the measurement device is the switched mode.
- A mode change only takes effect after a hard reset (disconnect the measurement device from the supply voltage while observing the safety regulations)!

8.2 "Switched mode" connection option

With this connection option, several devices (hardware components) are connected with each other in series:

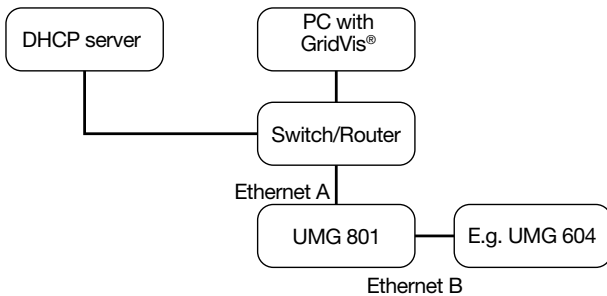

Switched mode:
Ethernet interface B of the UMG 801 for connecting an Ethernet device. The measurement device also allows the reverse use of the Ethernet interfaces (A for the Ethernet device and B for an IP address from a network).

8.3 "Dedicated mode" connection option

Connection option for 2 networks with different IP addresses (separately usable Ethernet interfaces for complex meter and module topologies, for example):

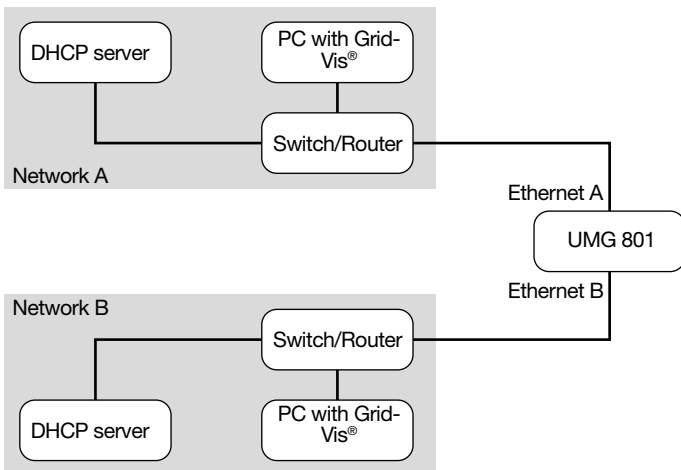

Dedicated mode:
Different IP addresses for Ethernet interfaces A and B for separate networks.

i INFORMATION

- In these figures, the connection exists only if
- The supply voltage is present at the UMG 801.
 - The UMG 801 has been started up.
- Also note the connection interruptions during restarts!

8.4 Meaning of the Ethernet interface LEDs:

LED	Function
Yellow	Blinks during network activity.
Green	Is illuminated when there is a connection (link)

9. PC connections and other interfaces

9.1 PC connections

The most common connection methods for communication of the measurement device with a PC (with GridVis® software installed) are described below.

1. Connection to a DHCP server and PC. The DHCP server automatically assigns IP addresses to the device and the PC.

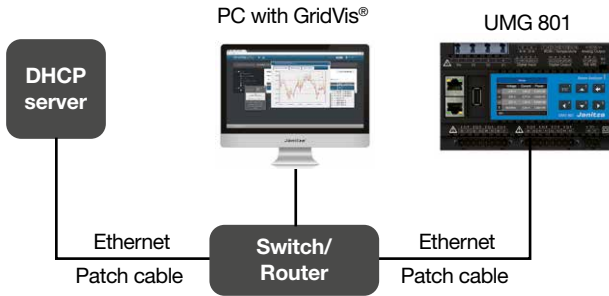

2. Connection as a client device (formerly master device) with an RS-485 bus structure to a PC and OPC UA client.

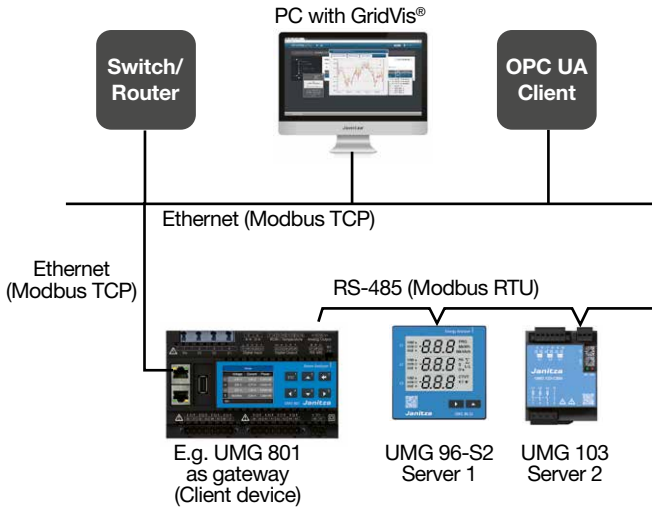

3. PC direct connection to the device. PC and device require a fixed IP address.

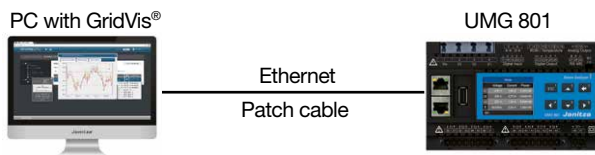

i INFORMATION

In a Modbus system, the Modbus organization (modbus.org) uses the terms "**client**" and "**server**" to describe Modbus communication. This is characterized by communication between **client devices - formerly master devices** - that initiate communication and make requests, and **server devices - formerly slave devices** - that process the requests and return an appropriate response (or error message).

i INFORMATION

For the configuration of the IP addresses on the meter, see Sect. "11.2 Configuring Ethernet (TCP/IP)" on p. 66.

9.2 RS-485 interface (serial interface)

The RS-485 interface of this device is designed as a 3-pole plug contact and communicates using the Modbus RTU protocol.

For the connection capacity of the terminals, see chapter „21. Technical specifications“ on page 134.

Examples of RS-485 interface - UMG 801

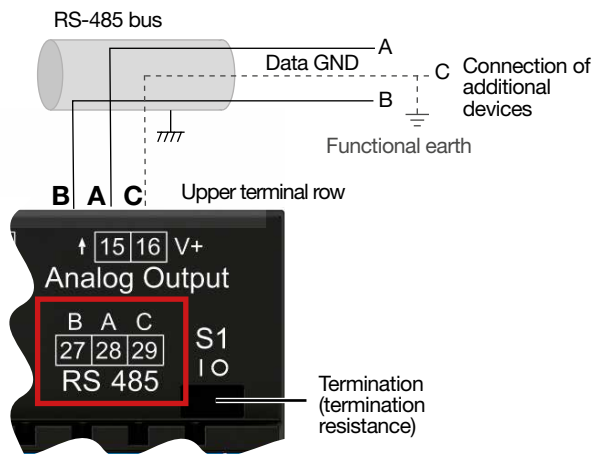

Fig. Example:
RS-485 interface of the UMG 801 (at the beginning of a bus topology - 3-pole plug contact).

i INFORMATION

- The device contains an integrated termination resistor (switch S1). For a UMG 801 at the beginning or end of a bus segment, terminate the device via the switch S1 - S1 to switch position "I" (on). For more details, see section „9.2.2 Termination resistors/Termination“ on page 57.
- CAT cables are not suitable for bus wiring! **Recommendation:** Use Unitronic Li2YCY(TP) 2x2x0.22 (Lapp cable) for bus wiring.
- A segment of an RS-485 bus structure can contain up to 32 nodes/devices. If there are more than 32 nodes/devices, use repeaters to connect segments.
- To prevent the addition of leakage currents when using several devices, install the Data GND as the functional earth (see adjacent figures)!

RS-485 interface - UMG 801:

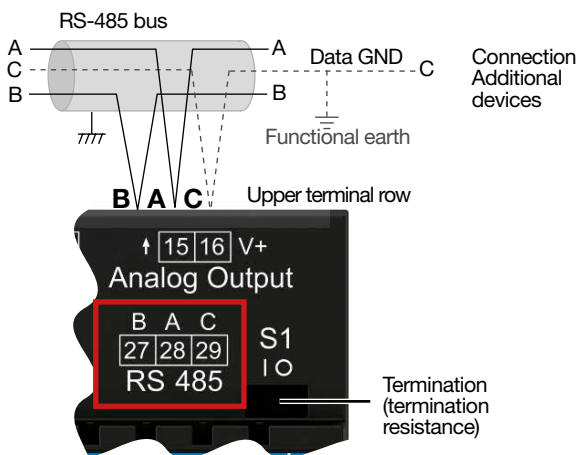

Illustration example:
RS-485 interface of the UMG 801 (in the middle of a bus topology - 3-pole plug contact).

9.2.1 Shielding

For connections via the interfaces, use a twisted and shielded cable and observe the following for the shielding:

- Ground the shields of all cables leading into the switchboard cabinet at the cabinet entrance.
- Route the cables into the switchboard cabinet through suitable cable inlets, e.g. PG glands.
- Connect the shield to a noiseless ground and ensure a large surface area with good conductivity.
- Do **NOT** connect the shield to terminal C (GND).
- Mechanically restrain the cables before the grounding clamp to prevent damage from cable movement (strain relief).

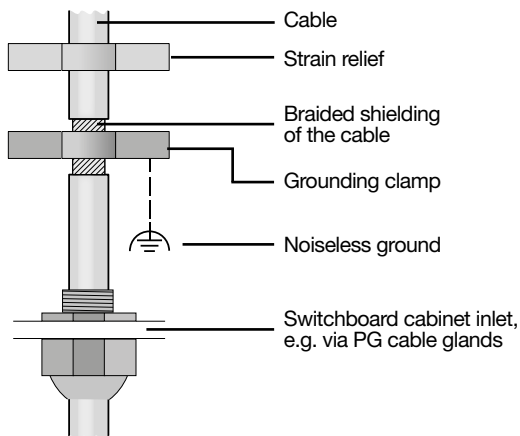
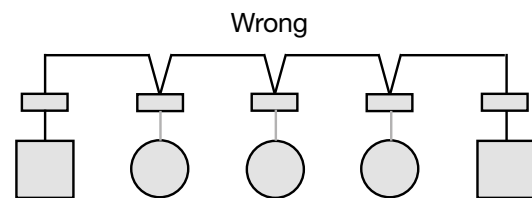
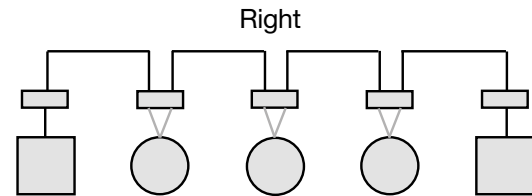





Fig. Shielding design at entrance to switchboard cabinet.

9.2.2 Termination resistors/Termination

The device contains an integrated termination resistor (S1). Terminate the beginning and the end of your bus segments with termination resistors (switch S1 of the UMG 801 = "I" or with termination resistor 120 Ω /0.25 W - see chapter „9.2.3 Bus structure (bus segment)“ on page 58).



-  Terminal strip (switchboard cabinet).
-  Device with RS-485 interface (Without termination resistor).
-  Device with RS-485 interface (Termination resistor on the device).

⚠ WARNING

Risk of injury due to high currents and high electrical voltages!

Atmospheric discharge can cause transmission errors and dangerous voltages on the device. Therefore please abide by the following:

- **Connect the cable shielding to functional earth (PE) at least once.**
- **For larger sources of interference or frequency converters in the switchboard cabinet, connect the shielding to functional earth (PE) as close to the device as possible.**
- **Comply with the maximum cable length of 1,200 m at a baud rate of 38.4 kbps.**
- **Use shielded cables.**
- **Route interface cables spatially separated or additionally insulated from mains voltage-carrying system components.**

9.2.3 Bus structure (bus segment)

In a bus structure:

- Connect all devices in line.
- Each device has its own device address.
- You can integrate up to 32 devices (nodes). Terminate the beginning and the end of your bus segment with termination resistors (inside the devices or with 120 Ω/0.25 W termination resistors).
- Use repeaters (signal amplifiers) to connect bus segments if there are more than 32 nodes.

- Devices with bus termination switched on must be powered.
- It is recommended that the client device (formerly master device) be placed at the end of a segment. If the client device is replaced with the bus termination switched on, the bus is out of operation.
- The bus can become unstable if a server device (formerly slave device) with bus termination switched on is replaced or is de-energized.
- Devices that are not involved in the bus termination can be replaced without the bus becoming unstable.

Fig. Representation of a bus structure

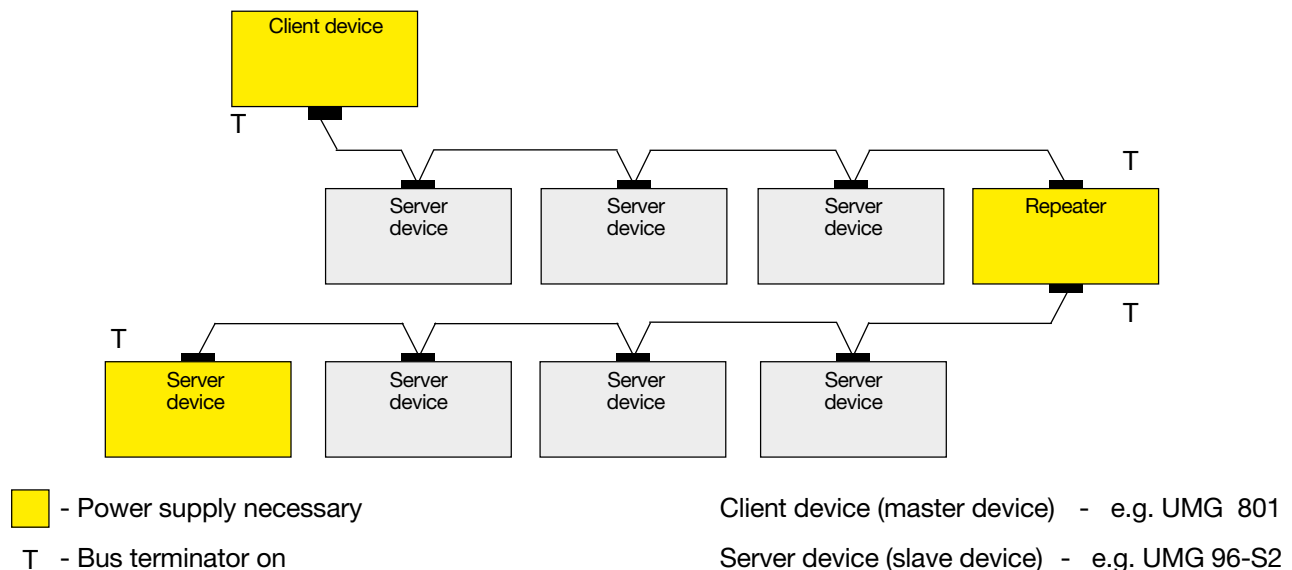

i INFORMATION

In a Modbus system, the Modbus organization (modbus.org) uses the terms "**client**" and "**server**" to describe Modbus communication. This is characterized by communication between **client devices - formerly master devices** - that initiate communication and make requests, and **server devices - formerly slave devices** - that process the requests and return an appropriate response (or error message).

9.3 JanBus interface

The JanBus interface:

- Is a proprietary interface that is used to connect the UMG 801 with modules (e.g. current measuring modules or digital input modules).
- Is located on the back of the meter and supplies connected modules with power.
- Information on connecting modules can be found in the usage information for the modules.

9.4 Digital inputs

The device has 4 digital inputs.

The device recognizes an input signal at the digital input if:

- A voltage of at least 18 V and at most 28 V DC (typically at 4 mA) is present.
- A current of at least 0.5 mA and at most 6 mA flows.

For voltages from 0 to 5 V and currents less than 0.5 mA there is no input signal.

i INFORMATION

Observe the polarity of the supply voltage!

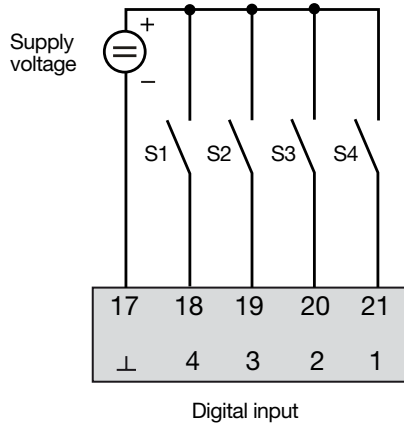

ATTENTION

Transmission error and material damage due to electrical malfunction.

With a cable length of more than 30 m, there is an increased probability of transmission errors and damage to the device due to atmospheric discharge!

Use shielded cables for the connections to the digital inputs and outputs!

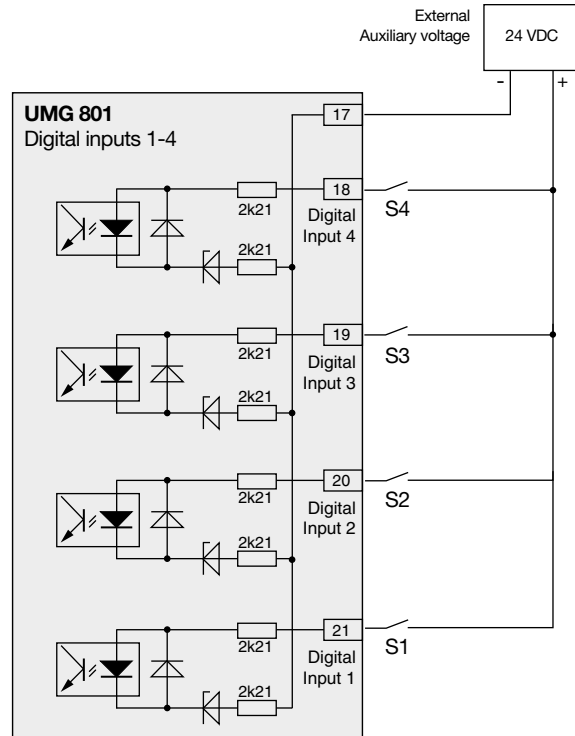

Fig. Example for the connection of external switching contacts S1 - S4 to digital inputs 1, 2, 3 and 4.

i INFORMATION

- For more details on the configuration of the digital inputs, see section „12. Digital inputs and outputs“ on page 84.
- Functions for the digital inputs can be configured easily and clearly in the GridVis® software (see www.janitza.com).
- The meter has the expansion option of up to 10 800-DI14 digital input modules (see digital input module usage information).

S0 - Pulse input

Each digital input is designed for the connection of an S0 pulse generator according to DIN EN 62053-31. An external auxiliary voltage with an output voltage in the range of 18 .. 28 VDC and a resistor of 1.5 kOhms are required.

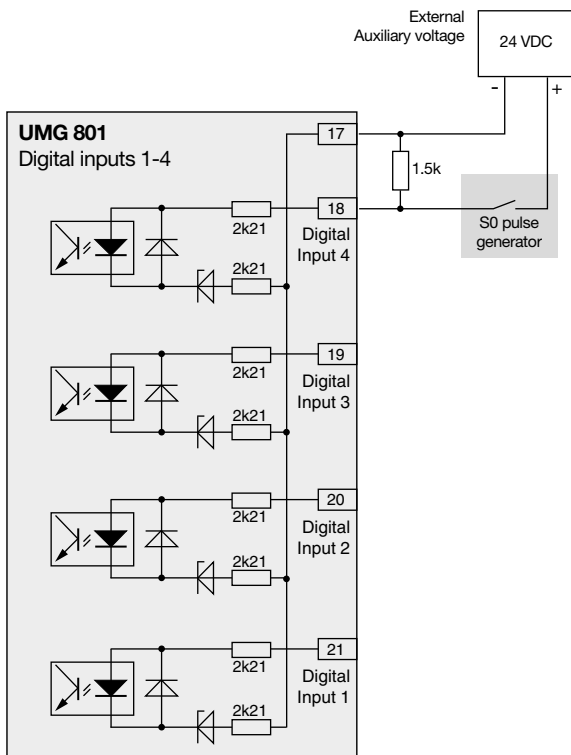

Example for the connection of an S0 pulse generator to digital input 1.

9.5 Digital outputs

The device has 4 digital outputs, which:

- Are electrically isolated from the evaluation electronics via optocouplers.
- Have a common reference.
- Are not short-circuit proof.
- Require an external auxiliary voltage.
- Can be used as pulse outputs to count energy consumption.
- Can switch DC and AC loads via relays or semiconductor electronics.
- Can be controlled via Modbus.

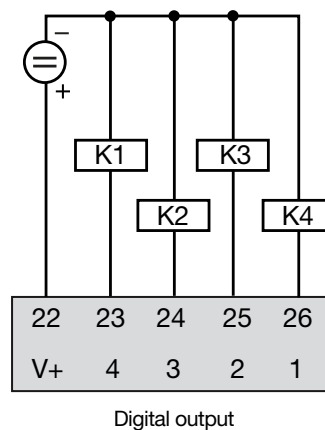

ATTENTION

Connection errors can damage the device and cause material damage.

The digital outputs are not short-circuit proof! Connection errors can therefore lead to damage to the connections.

Make sure that the wiring is correct when connecting the outputs.

INFORMATION

- For more details on the configuration of the digital outputs, see section „12. Digital inputs and outputs“ on page 84.
- Functions for the digital outputs can be configured easily and clearly in the GridVis® software (see www.janitza.com).
- To use the GridVis software®, your device requires a connection (interface) to a PC.
- When using the digital outputs as pulse outputs, measurement errors can occur due to residual ripple. For the supply voltage (DC) of the digital inputs and outputs, use power supplies whose residual ripple is less than 5% of the supply voltage.

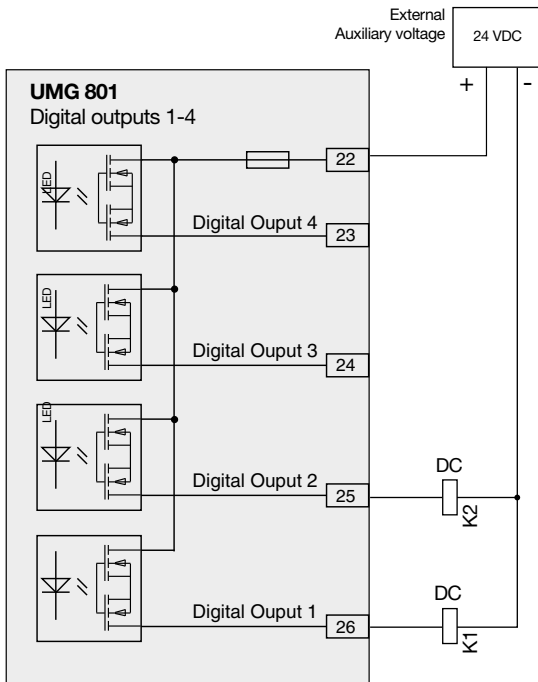

Connection example of two relays to the digital outputs

ATTENTION

Transmission error and material damage due to electrical malfunction.

With a cable length of more than 30 m, there is an increased probability of transmission errors and damage to the device due to atmospheric discharge!

Use shielded cables for the connections to the digital inputs and outputs!

9.6 Analog outputs

The device has a passive analog output which can output a current of 0 - 20 mA or 4 - 20 mA. An external power supply unit (24 V DC) is required for operation.

The connectable load must not exceed a resistance of 300 ohms. With larger resistors, the device limits the output range of the analog output to 20 mA.

You can configure the measured value assigned to the analog output, the start, average and end value as well as the output range 0 - 20 mA or 4 - 20 mA easily and clearly in the GridVis® software (**For further information on the configuration of the analog output, see section 13 on page 92**).

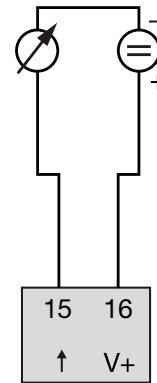

Analog output

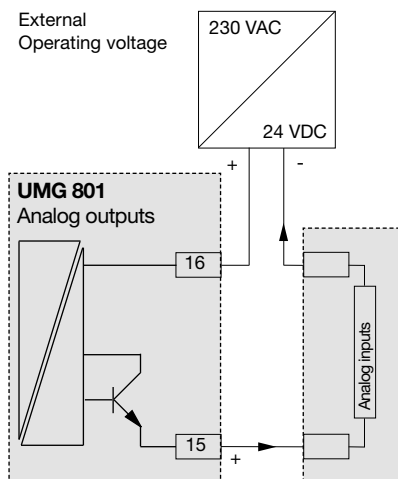

Connection example for the analog output

10. Operation and button functions

10.1 Controls

The device has a display and 6 function buttons to enable installation, commissioning and configuration without a PC. The 6 function buttons are used for:

- Selection of measured value displays.
- Navigation within the menus.
- Device configuration.

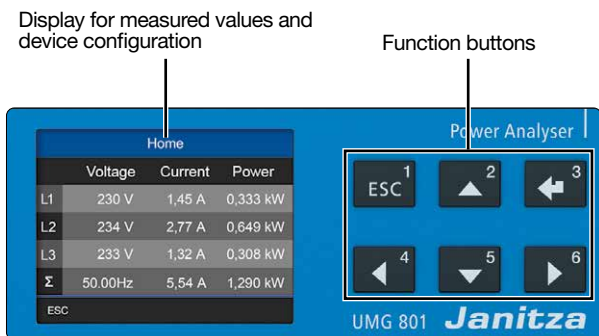

Fig. Measured value display UMG 801 "Home" and function buttons.

10.2 Function buttons

Button	Function
ESC 1	<ul style="list-style-type: none"> • Display menu. • One step back. • Cancel action (ESC) • Repeated actuation leads to the Menu.
▲ 2	<ul style="list-style-type: none"> • Select the menu or item (up, "▲"). • Change selection (digit +1).
↵ 3	<ul style="list-style-type: none"> • Confirm selection (Enter).
◀ 4	<ul style="list-style-type: none"> • Select position (to the left "◀").
▼ 5	<ul style="list-style-type: none"> • Select menu or item (down, "▼"). • Change selection (digit -1).
▶ 6	<ul style="list-style-type: none"> • Select position (to the right "▶").

Tab.: Function buttons

After restoration of network power, the device starts with the measured value display Home. Pressing function button 1 ESC displays the Menu.

10.3 Measuring display

After restoration of network power, the device starts with the measured value display Home.

i INFORMATION

Note that the duration of the system start-up (booting) of the device may vary (e.g. depending on the number of modules connected). The "Booting indicator" appears during system startup.

Home			
	Voltage	Current	Power
L1	230 V	1.45 A	0.333 kW
L2	234 V	2.77 A	0.649 kW
L3	233 V	1.32 A	0.308 kW
Σ	50.00Hz	5,54 A	1,290 kW
ESC			

Fig. Measured value display "Home"

10.4 Menu

Pressing button 1 ESC opens the Menu containing the selection of the parameters and measured variables to be set (menu items).

Menü	
Home	
Phasor Diagram	
Voltage	>
Current	>
Power	>

Fig. "Menu" window

10.5 PIN (password)

The "Configuration" of the device requires entry of a PIN (password). Default setting (factory setting) of the device PIN:

00000000

The "PIN" is used to protect against unauthorized access or accidental modification of the configuration data. The PIN configuration can be found at **Menu > Configuration > System > PIN**.

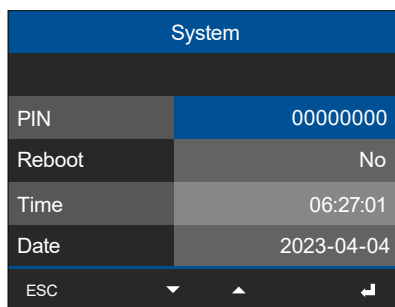

System	
PIN	00000000
Reboot	No
Time	06:27:01
Date	2023-04-04
ESC	

Display "System" > Entry "Password"

i INFORMATION

- **To configure the PIN, please refer to section 11.8.1 on page 73.**
- For security and to protect against accidentally changing the device's configuration data, change your PIN!
- **Make a note of your PIN and keep it safe!**
- You cannot configure your device without a PIN! If the PIN is lost, notify the manufacturer's Support!

10.6 Overview of menu displays

Menu

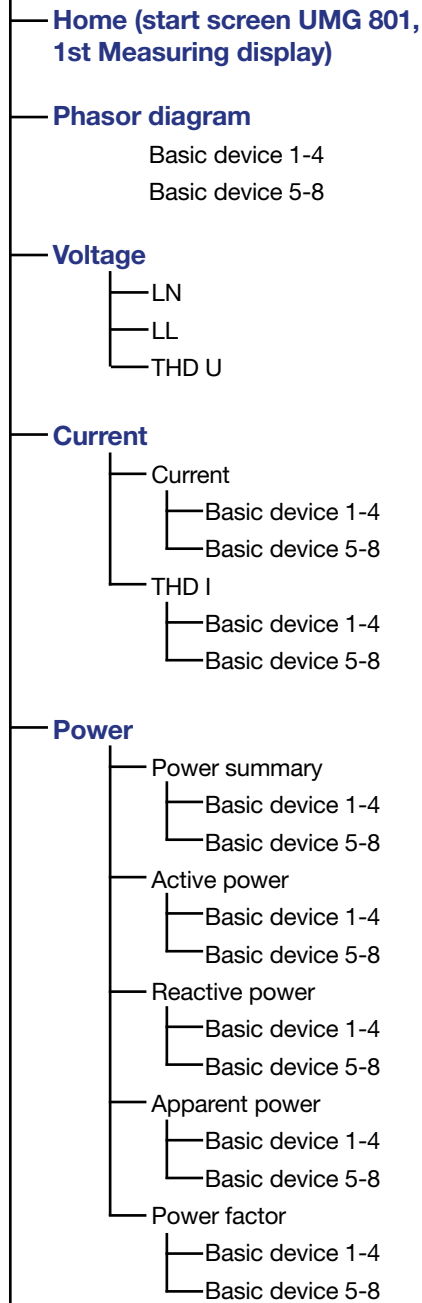

Energy

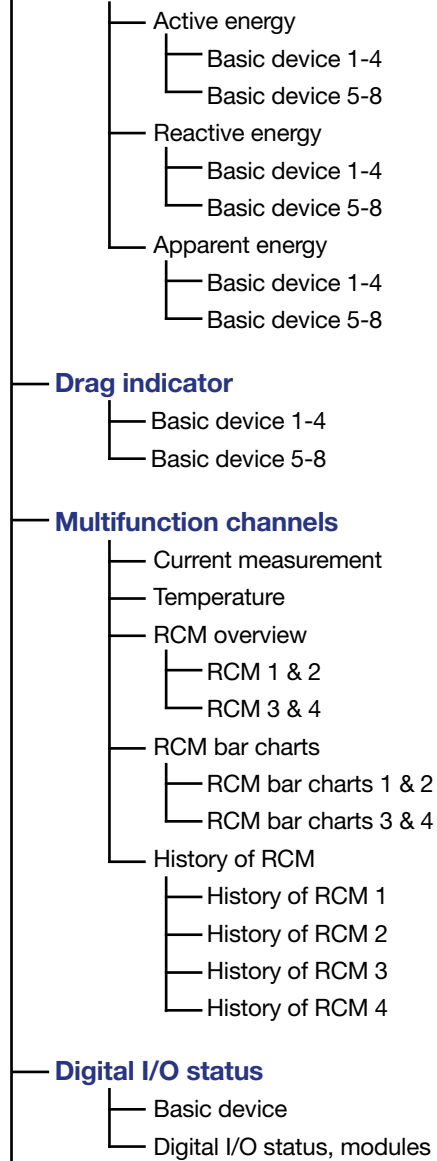

Configuration

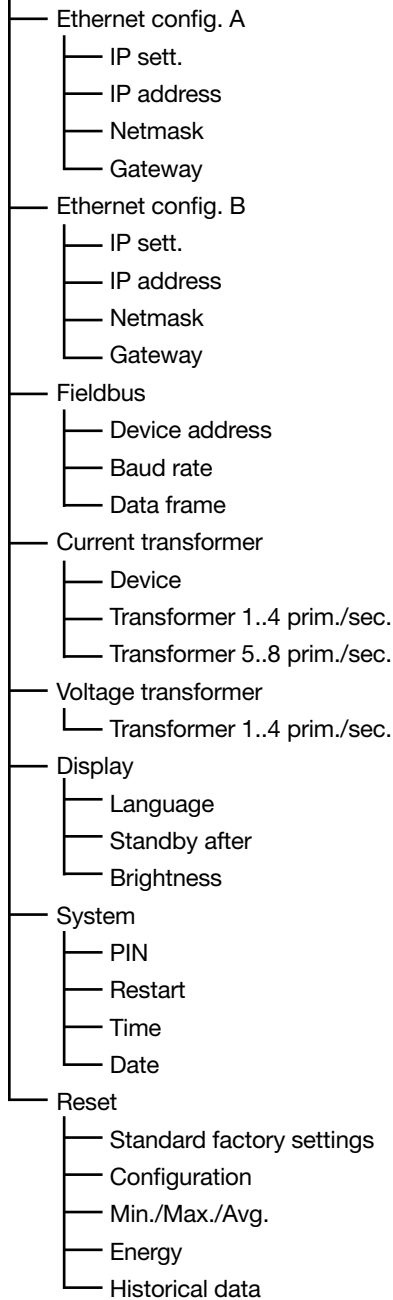

Diagnostics

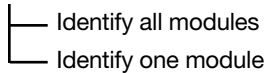

System information

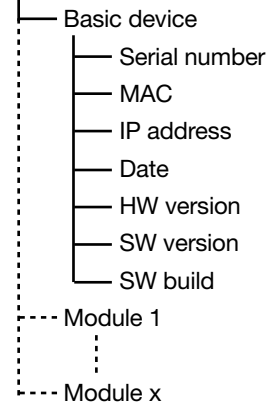

Select the menu item:

- Press button 1 *ESC*.
- The *Menu* window appears.
- Use the buttons 2 “▲” and 5 “▼” to select your menu item.
- Confirm your menu entry with button 3 *Enter*.
- The window of the selected menu item appears.
- Button 1 *ESC* undoes your step, or pressing it several times takes you back to the *Menu* window.

11. Configuration

11.1 The Configuration window

The Configuration menu of the device contains all parameters in which you make settings. The device requires the supply voltage for configuration. See section „14. Commissioning“ on page 94 on this.

- If you are in the measured value display *Home*, pressing button 1 *ESC* takes you to the *Menu* window.

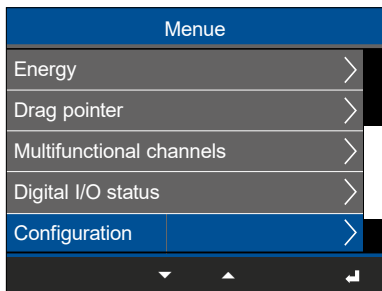

Fig. Window Menu -> Configuration item

- Use buttons 2 (▲) and 5 (▼) to select the menu item *Configuration* and confirm with button 3 *Enter*.
- The *Configuration* window appears.

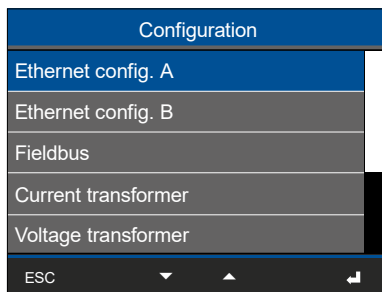

Fig. Configuration window

i INFORMATION

Password-protected devices require entry of a password before configuration! If your device is password protected, enter your password to access the *Configuration* window (see section „10.5 PIN (password)“ on page 63).

11.2 Configuring Ethernet (TCP/IP)

i INFORMATION

- **Consult your network administrator for the Ethernet network settings for your device.**
- Information on the connection and communication of your device with the software can be found in the online help for the GridVis® software.

After restoration of network power, the device starts with the measured value display *Home*.

- Press function button 1 *ESC* to open the menu.
- Use buttons 2 (▲) and 5 (▼) to select the menu item *Configuration* and confirm with button 3 *Enter*.
- The *Configuration* window appears with the items *Ethernet Config. A* and *Ethernet Config. B*.

To configure the Ethernet settings, also refer to the descriptions in Sect. “8.1 Functions of the Ethernet interfaces” on p. 52 and the Sect. “11.2.1 Communication via TCP/IP” on p. 67.

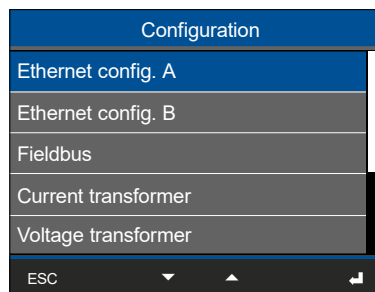

Fig. Configuration window -> Ethernet External item

- Use buttons 2 (▲) and 5 (▼) to select the item *Ethernet config. A* and confirm with button 3 *Enter*.
- The *Ethernet Config. A* window appears with the parameters for Ethernet communication.

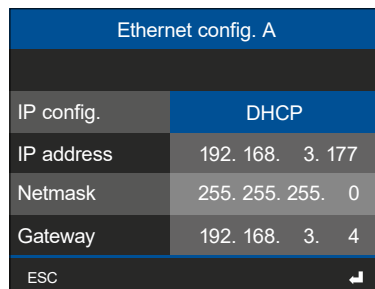

Fig. Ethernet External window

- Configure *Ethernet config. B* in the same way as *Ethernet config. A*.

11.2.1 Communication via TCP/IP

The following applies for *Ethernet config. A* and *Ethernet config. B*:

The device has 2 types of address assignment for the Ethernet connections (TCP/IP):

1. Static (fixed IP address)

The user selects the IP address, netmask and gateway on the meter. Use this mode for networks without a DHCP server.

2. DHCP

At startup, the measurement device automatically receives an IP address, netmask and gateway from the DHCP server.

The default setting of the measurement device for Ethernet interfaces A and B is DHCP!

Ethernet config. A	
IP config.	DHCP
IP address	192. 168. 3. 177
Netmask	255. 255. 255. 0
Gateway	192. 168. 3. 4
ESC	

Fig. Ethernet (TCP/IP) window

Configure your Ethernet (TCP/IP) settings via the function buttons (see chap. 10.2 on page 62) as follows:

- Select the item *IP configuration* (type of address assignment) and press button 3 *Enter*.
- The item *DHCP* (default setting) blinks "yellow".
- If necessary, switch between the types of address assignment using buttons 2 (▲) and 5 (▼).
- Confirm your selection by pressing button 3 *Enter*.
- Go to the item *IP Address* (button 2 "▲" and 5 "▼") and press button 3 *Enter*.
- The IP address entry blinks "yellow".
- Use buttons 4 (◀) and 6 (▶) to change the position of the digit to be set and buttons 2 (▲) and 5 (▼) to change the digit (-1/+1).

Tip! Start by setting the right digit of each block of three.

- Finally, confirm your entry for the *IP address* with button 3 *Enter*.

- The configuration of the *Netmask* and the *Gateway* require the same procedure.
- When you have finished entering data, press button 1 *ESC* to return to the *Menu* window.

11.2.2 Communication via OPC UA

The data transfer using the OPC UA protocol takes place via the Ethernet interfaces of your meter.

The Ethernet interface and the data transfer using the OPC UA protocol can be configured conveniently in the GridVis® software.

From firmware version 1.6.0, the measurement device supports "Static node IDs" on the OPC UA server. Static nodes always have the same ID!

Nodes in a certain number range of node IDs have either a static or a dynamic node ID. The ID range for static nodes can be found in the information of the corresponding "Namespace" in the server area of the OPC UA tree.

In contrast to static node IDs, dynamic node IDs can change. For example, after a restart, an update, a reconfiguration or other changes (e.g. changes to the recording duration).

i INFORMATION

- Consult your network administrator for the correct Ethernet network settings for your measurement device.
- Information on the connection and communication of your measurement device with the software can be found in the online help for the GridVis® software.

11.3 Configuring the fieldbus (RS-485 interface)

After restoration of network power, the device starts with the default display *Home*.

- Press function button 1 *ESC* to open the menu.
- Use buttons 2 “▲” and 5 “▼” to select the menu item *Configuration* and confirm with button 3 *Enter*.
- The *Configuration* window with the entry *Fieldbus* appears.

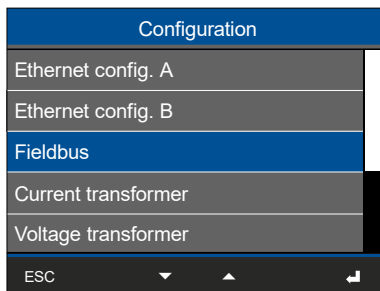

Fig. Window Configuration -> Fieldbus item

- Use buttons 2 “▲” and 5 “▼” to select the menu item *Fieldbus* and confirm with button 3 *Enter*.
- The window *Fieldbus* appears with the parameters:
 - Device address.
 - Baud rate.
 - Data frame.

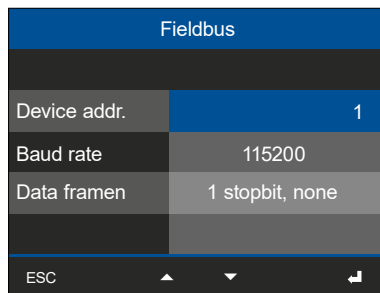

Fig. Fieldbus window

- Configure the parameters for the fieldbus (RS-485 interface) by selecting the respective item and confirming with button 3 *Enter*.
- Depending on the parameter selected, the corresponding item is shown in "yellow".
- Use buttons 4 (◀) and 6 (▶) to change the position of the digit to be set and buttons 2 (▲) and 5 (▼) to change the digit (-1/+1).
- Confirm your entries with button 3 *Enter* or end the action by pressing button 1 *ESC*.
- When you have finished entering data, press button 1 *ESC* to return to the *Menu* window.

11.3.1 Communication settings

• **Device address:**

Select a device address for the device with which the device can be addressed in the bus structure. Each device address exists once in a bus structure! (See section „9.2 RS-485 interface (serial interface)“ on page 56)

Setting range: 1 - 247 (according to the Modbus standard)

Default setting: 1

• **Baud rate:**

Select a uniform baud rate for all devices in the bus structure!

Setting range: 9600, 19200, 38400, 57600, 115200 kbps.

Default setting: 115200 kbps

• **Data frame:**

Select a uniform data framework for all devices in the bus structure. Setting range:

- "1 stop bit, odd" (parity odd, with 1 stop bit)
- "1 stop bit, even" (parity even, with 1 stop bit)
- "1 stop bit, none" (parity none, with 1 stop bit).
- "2 stop bits" (parity none, with 2 stop bits).
- **Default value: 1 stop bit, none (no parity).**

ATTENTION

Material damage due to incorrect network settings!

Incorrect network settings can cause malfunctions in the IT network.

Consult your network administrator for the correct network settings for your device.

11.4 Configuring current transformers

i INFORMATION

Before configuring the current transformer ratios, be certain to connect the transformers in compliance with the specifications on the device rating plate and the technical data!

- Press function button 1 *ESC* to open the menu.
- Use buttons 2 “▲” and 5 “▼” to select the menu item *Configuration* and confirm with button 3 *Enter*.
- The *Configuration* window appears.
- In the *Configuration* window, use buttons 2 “▲” and 5 “▼” to select the menu item *Current transformers* and confirm with button 3 *Enter*.

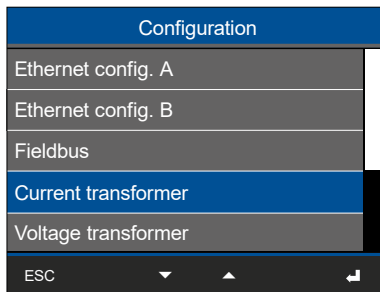

Fig. Window Configuration -> item Current transformer

- The *Current transformers* window appears.

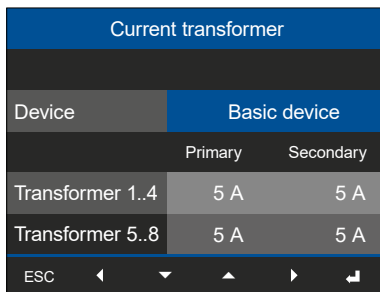

Fig. Window Current transformer -> item Device

- In the *Current transformers* window, choose the item *Device* and confirm with button 3 *Enter*.
- The *Device* item is shown in "blue".
In the *Device* item, choose between the basic device and any additional current measuring modules that may be connected.
- Confirm the *Basic device* item with button 3 *Enter*.
- Use button 5 “▼” to go to the setting for the primary side of the current transformers (current measurement inputs I1..I4).

- The item for the primary side of the current transformers I1..I4 is marked in “blue”.

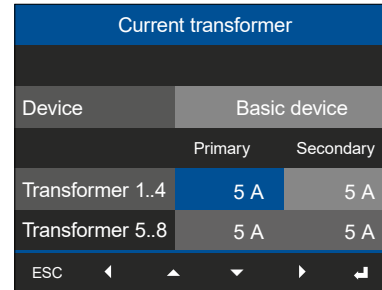

Fig. Window Current transformer -> item Primary for current transformer 1..4.

- Press button 3 *Enter*.
- The item for the primary side of the current transformers I1..I4 “blinks”.
- Use buttons 4 (◀) and 6 (▶) to change the position of the digit to be set and buttons 2 (▲) and 5 (▼) to change the digit (-1/+1).
- Confirm your entries with button 3 *Enter* or end the action by pressing button 1 *ESC*.
- Use button 6 (▶) to go to the configuration of the secondary side of the current transformers I1..I4.
- Configure the secondary side of the current transformers I1..I4 in the same way.
- Confirm your entries with button 3 *Enter* or end the action by pressing button 1 *ESC*.
- When you have finished entering data, press button 1 *ESC* to return to the *Menu* window.
- For the configuration of the **Current transformer ratios I5..I8**, press button 5 “▼” to go to the configuration of the primary side of the current transformers I5..I8.
- Configure the **Current transformer ratios I5..I8** in accordance with the current transformer ratios I1..I4!

i INFORMATION

You can also configure current and voltage transformer ratios

- in the device configuration of the **GridVis®** software. A description of the configuration in the software can be found in the corresponding online help and tutorials.
- via the integrated web server (see Sect. “18. Device homepage” on p. 120).

Current transformer settings (I1..I4 and I5..I8):

Current transformer (primary):
 Setting range 1 - 10000 A
Default value: 5 A

Current transformer (secondary):
 Setting range 1 - 5 A
Default value: 5 A

11.5 Configuring voltage transformers

***i* INFORMATION**

Before configuring the voltage transformer ratios, be certain to connect the transformers in compliance with the specifications on the device rating plate and the technical data!

- Press function button 1 *ESC* to open the *Menu* window.
- Use buttons 2 “▲” and 5 “▼” to select the menu item *Configuration* and confirm with button 3 *Enter*.
- The *Configuration* window appears.
- In the *Configuration* window, use buttons 2 “▲” and 5 “▼” to select the item *Voltage transformer* and confirm with button 3 *Enter*.

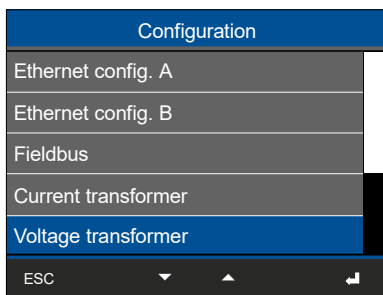

Fig. Window Configuration -> item Voltage transformer

- The *Voltage transformer* window appears with the item for the primary side 1..4 marked “blue”.

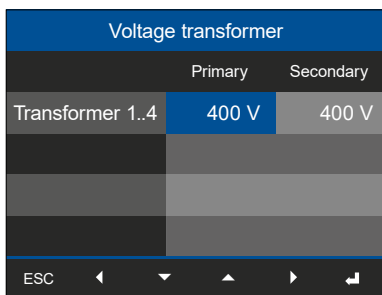

Fig. Window Voltage transformer -> item Primary for voltage transformer 1..4.

- Confirm with button 3 *Enter*.
- The item for the primary side of the voltage transformers 1..4 “blinks”.
- Use buttons 4 (◀) and 6 (▶) to change the position of the digit to be set and buttons 2 (▲) and 5 (▼) to change the digit (-1/+1).
- Confirm your entries with button 3 *Enter* or end the action by pressing button 1 *ESC*.
- Use button 6 (▶) to go to the configuration of the secondary side of the voltage transformers 1..4.
- Configure the secondary side of voltage transformers 1..4 in the same way.
- Confirm your entries with button 3 *Enter* or end the action by pressing button 1 *ESC*.
- When you have finished entering data, press button 1 *ESC* to return to the *Menu* window.

Voltage transformer settings (1..4):

Voltage transformer (primary):
 Setting range 100 - 60000 V
Default value: 400 V

Voltage transformer (secondary):
 Setting range 100 - 480 V
Default value: 400 V

11.6 Temperature measurement configuration

As already described in Sect. "7.6 Multifunction channels" on p. 40, temperature measurements on the UMG 801 can optionally be carried out via the multifunction channels.

The UMG 801 temperature measurement can be configured in the GridVis® software (for more information, see the "Online help" for the software).

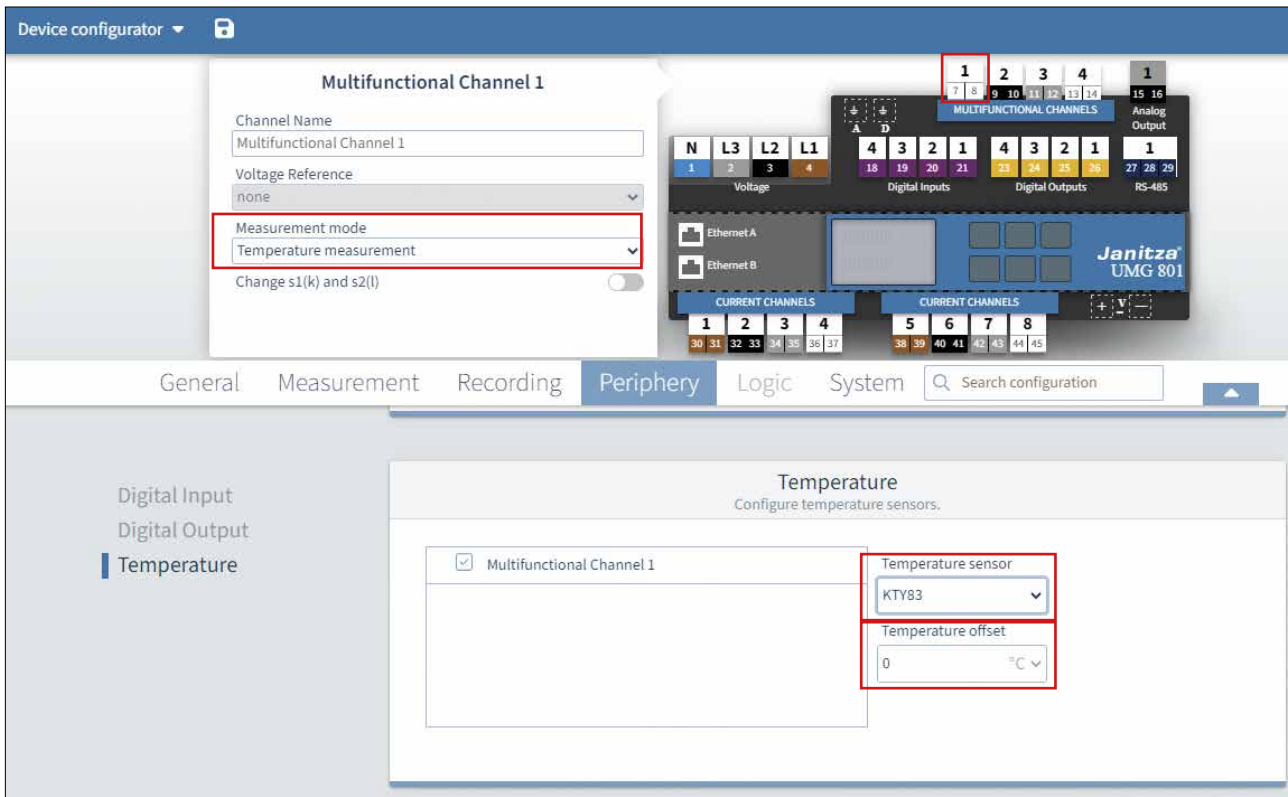

Fig. Wizard for configuring the temperature measurement in the GridVis® software.

11.6.1 Temperature sensor types

Permitted temperature sensor types can be found in the Sect. "7.9 Temperature measurement" on p. 50 and in the „Technical specifications“ on page 134.

11.6.2 "Temperature offset" item

Input option for a temperature offset (temperature shift) to a defined temperature value.

11.7 Configuring the display

Use the *Display* item of the meter to configure the following settings:

1. Language
2. Standby (after)
3. Brightness

11.7.1 Language

Using the *Language* item of the *Display* window, configure the language for the device's user interface:

- Press function button 1 *ESC* to open the *Menu* window.
- Use buttons 2 “▲” and 5 “▼” to select the menu item *Configuration* and confirm with button 3 *Enter*.
- The *Configuration* window appears.
- In the *Configuration* window, use buttons 2 “▲” and 5 “▼” to select the item *Display* and confirm with button 3 *Enter*.

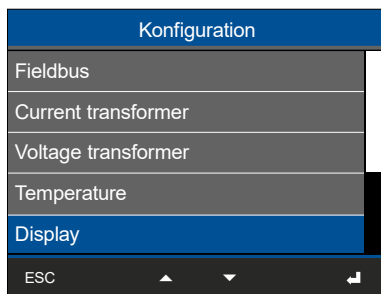

Fig. Window Configuration -> item Display

- The *Display* window appears with the *Language* item marked in “blue”.

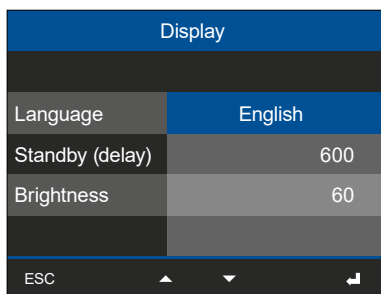

Fig. Window Display -> item Language

- Press button 3 *Enter*.
- The item *Language* appears in “yellow”.

- Use buttons 2 “▲” and 5 “▼” to select the language (**German** or **English**) and confirm with button 3 *Enter*.
- The user interface entries change to the selected language.
- Use button 1 *ESC* to return to the menu.

11.7.2 Standby (after)

Time in seconds after which the display brightness switches to the set brightness (Standby after).

Setting range: 10 s - 3600 s

Default value: 600 s

- Open the *Display* window as previously described.
- In the *Display* window, press button 5 “▼” to select the item *Standby (after)*. Press button 3 *Enter*.

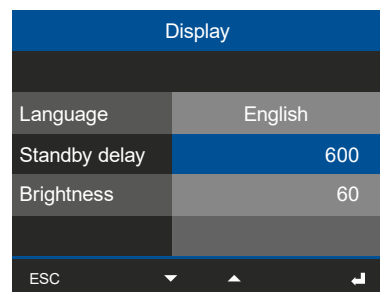

Fig. Window Display -> item Brightness

- The item *Standby (after)* appears in “yellow”.
- Use buttons 4 (◀) and 6 (▶) to change the position of the digit to be set and buttons 2 (▲) and 5 (▼) to change the digit (-1/+1).
- Confirm your entries with button 3 *Enter* or end the action by pressing button 1 *ESC*.
- When you have finished entering data, press button 1 *ESC* to return to the *Menu* window.

11.7.3 Brightness

Use the item *Brightness* of the *Display* window to configure the brightness of the device display.

Setting range: 10% - 100%

Default value: 60%

Setting 10% = dark

100% = very bright

- Open the *Display* window as previously described.
- In the *Display* window press button 5 “▼” to select the item *Brightness*.

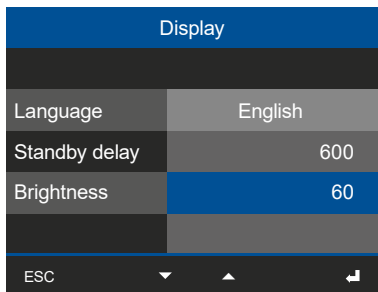

Fig. Window Display -> item Brightness

- Press button 3 *Enter*.
- The item *Brightness* appears in “yellow”.
- Use buttons 4 (◀) and 6 (▶) to change the position of the digit to be set and buttons 2 (▲) and 5 (▼) to change the digit (-1/+1).
- Confirm your entries with button 3 *Enter* or end the action by pressing button 1 *ESC*.
- When you have finished entering data, press button 1 *ESC* to return to the *Menu* window.

11.8 Configuring the system

Use the *System* item of the meter to configure the following settings:

1. PIN
2. Restart (reboot)
3. Time
4. Date

11.8.1 PIN

The “*PIN*” function on the device is provided to protect the device's configuration data from unauthorized access or unintentional modification. The PIN consists of an 8-digit number combination. The default setting of the device PIN is:

00000000

Please note!

The PIN “00000000” allows open access to the device configuration (no PIN query)!

For security and to protect against accidentally changing the device's configuration data, change your PIN!

Setting a new PIN

- Open the *Configuration* window as previously described.
- In the *Configuration* window, use buttons 2 “▲” and 5 “▼” to select the item *System* and confirm with button 3 *Enter*.
- In the *System* window, use buttons 2 “▲” and 5 “▼” to select the item *PIN* (marked in “blue”) and confirm with button 3 *Enter*.

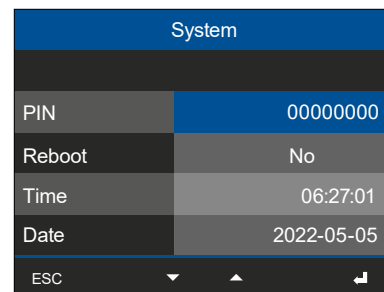

Fig. Window System -> item Password

- The item *PIN* appears in “yellow”.
- Use buttons 4 (◀) and 6 (▶) to change the position of the digit to be set and buttons 2 (▲) and 5 (▼) to change the digit (-1/+1).

- Confirm your entries with button 3 *Enter* or end the action by pressing button 1 *ESC*.
- The configuration data of the device are now protected with a **new PIN**.
- When you have finished entering data, press button 1 *ESC* to return to the *Menu* window.

i INFORMATION

- The meter’s factory setting is **PIN 00000000**.
- For security and to protect against accidentally changing the device's configuration data, change your PIN!
- **Make a note of your PIN and keep it safe!**
- You cannot configure your device without a PIN! If the PIN is lost, notify the manufacturer's Support!

11.8.2 Restart (reboot)

This function restarts the device.

- Open the Configuration window as previously described.
- In the *Configuration* window, use buttons 2 “▲” and 5 “▼” to select the item *System* and confirm with button 3 *Enter*.
- The *System* window appears.
- In the *Reset* window, use buttons 2 “▲” and 5 “▼” to select the item *Restart* (marked in "blue") and confirm with button 3 *Enter*.

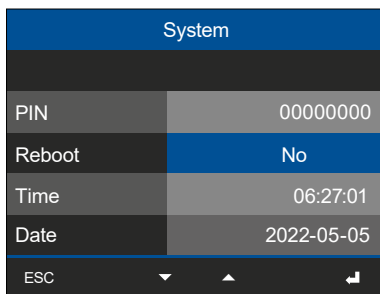

Fig. System window -> Restart item

- The item *Reboot* appears in “yellow”.
- Use the buttons 2 “▲” and 5 “▼” to select “Yes” or “No”.
- After confirming the entry “Yes” with button 3 *Enter*, a warning appears.
- Confirm the warning with button 3 *Enter* or end the action by pressing button 1 *ESC*.
- Pressing button 3 *Enter* **restarts the device** (takes about 2 minutes).
- The measured value display appears “Home”.

11.8.3 Time

You can change the settings for the time, the time synchronization and the time zones using the **Grid-Vis® software**.

The **Time display** can be accessed under **Menu > Configuration > System > Time**.

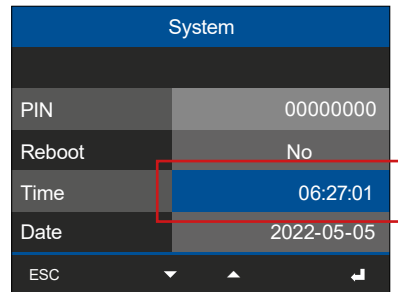

Fig. System window -> Time item

i INFORMATION

The synchronization of the measurement device time with the Network Time Protocol (NTP) can be configured in the **GridVis® software**. Please note that the measurement device can require **up to 1 h** for the transfer of the NTP time stamp.

- via the integrated web server (see Sect. “18. Device homepage” on p. 120).

11.8.4 Date

You can change settings for the date using the **Grid-Vis® software**.

The **Date display** can be accessed using **Menu > Configuration > System > Date**.

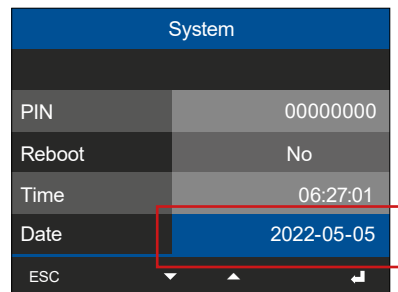

Fig. System window -> Date item

11.9 Reset

In the Reset window, you can delete existing configurations and/or restore the factory settings.

11.9.1 Standard factory settings

This measurement device function resets the following parameters to the factory settings:

- Configurations
- Power quality data and recordings.
- Stored measured values (min., max., average values).
- Energy values.
- Historical data.

i INFORMATION

Please note! This function deletes the above parameters in the meter!

- Open the Configuration window as previously described.
- In the *Configuration* window, use buttons 2 "▲" and 5 "▼" to select the item *Reset* and confirm with button 3, *Enter*.
- The *Reset* window appears.

Reset	
Factory settings	No
Configuration	No
Min./Max./Avg.	No
Energy	No
Historical data	No
ESC	

Fig. Reset window -> Factory settings item

- In the *Reset* window, use buttons 2 "▲" and 5 "▼" to select the item *Factory settings* (marked in "blue") and confirm with button 3 *Enter*. The item *Factory settings* appears in "yellow."
- Use the buttons 2 "▲" and 5 "▼" to select "Yes" or "No".
- After confirming the entry "Yes" with button 3 *Enter*, a warning appears.
- Confirm the warning with button 3 *Enter* or end the action by pressing button 1 *ESC*.
- Pressing button 3 *Enter* boots the meter and **resets it to the factory settings** (takes about 1 minute).
- The measured value display appears "Home".

11.9.2 Reset configuration

This function deletes all the configuration data of your measurement device. It is not possible to select specific configuration data.

i INFORMATION

Please note! This function deletes all configured values in the meter and loads the factory settings!

- Open the Configuration window as previously described.
- In the *Configuration* window, use buttons 2 "▲" and 5 "▼" to select the item *Reset* and confirm with button 3, *Enter*.
- The *Reset* window appears.
- In the *Reset* window, use buttons 2 "▲" and 5 "▼" to select the item *Configuration* (marked in "blue") and confirm with button 3 *Enter*.

Reset	
Factory settings	No
Configuration	No
Min./Max./Avg.	No
Energy	No
Historical data	No
ESC	

Fig. Reset window -> Configuration item

- The item *Configuration* appears "yellow".
- Use the buttons 2 "▲" and 5 "▼" to select "Yes" or "No".
- After confirming the entry "Yes" with button 3 *Enter*, a warning appears.
- Confirm the warning with button 3 *Enter* or end the action by pressing button 1 *ESC*.
- Pressing button 3 *Enter* boots the meter and **loads the factory settings** (takes about 1 minute).
- The measured value display appears "Home".

11.9.3 Reset minimum, maximum and average values

Using this function also deletes all the current minimum, maximum and average values as well as the drag indicator in the measurement device at the same time.

i INFORMATION

- **This function deletes the instantaneous values in the measurement device!**
 - Before commissioning, delete any production-related contents of the energy meters, minimum, maximum and average values and recordings!
-
- Open the Configuration window as previously described.
 - In the *Configuration* window, use buttons 2 "▲" and 5 "▼" to select the item *Reset* and confirm with button 3, *Enter*.
 - The *Reset* window appears.
 - In the *Reset* window, use buttons 2 "▲" and 5 "▼" to select the item *Min./Max./Avg. values* (marked in "blue") and confirm with button 3 *Enter*.

Reset	
Factory settings	No
Configuration	No
Min./Max./Avg.	No
Energy	No
Historical data	No
ESC	

Fig. Reset window -> Min./Max./Avg. values item

- The item *Min./Max./Avg. values* appears "yellow".
- Use the buttons 2 "▲" and 5 "▼" to select "Yes" or "No".
- After confirming the entry "Yes" with button 3 *Enter*, a warning appears.
- Confirm the warning with button 3 *Enter* or end the action by pressing button 1 *ESC*.
- Pressing button 3 *Enter* **clears the measurement device minimum, maximum and average values.**
- Press button 1 *ESC* to return to the *Menu* window.

11.9.4 Reset energy values

Use this function to delete all current energy values in the meter. It is not possible to select specific energy values.

i INFORMATION

- **This function deletes the energy values in the measurement device!**
 - Before commissioning, delete any production-related contents of the energy meters, minimum, maximum and average values and recordings!
-
- Open the Configuration window as previously described.
 - In the *Configuration* window, use buttons 2 "▲" and 5 "▼" to select the item *Reset* and confirm with button 3, *Enter*.
 - The *Reset* window appears.
 - In the *Reset* window, use buttons 2 "▲" and 5 "▼" to select the item *Energy* (marked in "blue") and confirm with button 3 *Enter*.

Reset	
Factory settings	No
Configuration	No
Min./Max./Avg.	No
Energy	No
Historical data	No
ESC	

Fig. Reset window -> Energy item

- The item *Energy* appears "yellow".
- Use the buttons 2 "▲" and 5 "▼" to select "Yes" or "No".
- After confirming the entry "Yes" with button 3 *Enter*, a warning appears.
- Confirm the warning with button 3 *Enter* or end the action by pressing button 1 *ESC*.
- Pressing button 3, *Enter*, **deletes the measurement device energy values.**
- Press button 1 *ESC* to return to the *Menu* window.

11.9.5 Reset historical data

The device user can use this function to delete all historical values and data. It is not possible to select specific historical values.

i INFORMATION

This function deletes all historical values, power quality data, Comtrade files, recordings and stored min./max./avg. values in the meter!

- Open the Configuration window as previously described.
- In the *Configuration* window, use buttons 2 “▲” and 5 “▼” to select the item *Reset* and confirm with button 3, *Enter*.
- The *Reset* window appears.
- In the *Reset* window, use buttons 2 “▲” and 5 “▼” to select the item *Historical data* (marked in “blue”) and confirm with button 3 *Enter*.

Reset	
Factory settings	No
Configuration	No
Min./Max./Avg.	No
Energy	No
Historical data	No
ESC	▼ ▲ ↵

Fig. Reset window -> Energy item

- The item *Historical data* appears “yellow”.
- Use the buttons 2 “▲” and 5 “▼” to select “Yes” or “No”.
- After confirming the entry “Yes” with button 3 *Enter*, a warning appears.
- Confirm the warning with button 3 *Enter* or end the action by pressing button 1 *ESC*.
- Pressing button 3 *Enter* **deletes the historical data of the meter.**
- Press button 1 *ESC* to return to the *Menu* window.

11.10 Module identification / diagnostics

i INFORMATION

Before you start the module identification function (*Diagnostics* menu item) on the basic device, please make sure that the modules are mounted and connected correctly. Only correctly installed modules connected to the basic device guarantee the supply of power and data transmission.

The basic device provides the option of extending the range of functions (e.g. current measuring modules and/or digital input modules). The basic device recognizes the plugged in module automatically. The module identification can be configured via the ***Diagnostics*** menu item.

i INFORMATION

Detailed information about the modules, the *Diagnostics* menu item and on module identification can be found in the user manual of the modules.

11.11 Events and transients

The measurement device contains functions and triggers (pulses that trigger processes) that can, for example, point out to a plant operator the energy supply quality requirements that have not been met. Events and transients are considered power quality parameters for evaluating supply reliability. The measurement device records half-wave RMS values (HW RMS) and waveforms.

i INFORMATION

- The events and transients for the UMG 801 can be configured in the GridVis® software. Program help and online help provide assistance with the configuration.
- The UMG 801 only records events and transients for the voltage measurement group and for the 1st and 2nd current measurement group!
- The event browser in the GridVis® software visualizes events and transients in list format and in curve displays for evaluation and analysis of the power quality parameters.

11.11.1 Events

The meter has the following power quality parameters (events), which it obtains through observation of half-wave RMS values (HW RMS). The limit values for this must be configured in relation to the nominal values and the corresponding hysteresis (*):

Current measurement

- *Overcurrent* event

Voltage measurement

- *Rapid voltage change* event
- *Voltage interruption* event
- *Overvoltage* event
- *Undervoltage* event

Frequency measurement

- *Frequency change* event
- *Overfrequency* event
- *Underfrequency* event

11.11.2 Transients

The detection of transients in the measurement device

- works by comparing the momentary sample value (measured value) with a limit value --> "**Absolute**" mode.
- The difference between the sample value of the current period and the sample value of the previous period. The result is compared with the static, configured limit value --> "**Envelope**" mode.
- The comparison of the momentary sample value (measured value) with the previous sample value --> "**Rapid increase**" mode.

The measurement device has the following power quality parameters (transients) which allow the configuration of limit values:

Current measurement

- Transient *Rapid overcurrent* (absolute current)

Voltage measurement

- Transient *Rapid overvoltage* (absolute voltage)
- Transient *Voltage envelope*
- Transient *Voltage rapid increase*

Automatic acquisition of transients can be configured for the measurement device using a "Slide button" in the GridVis software. The following table shows corresponding transient limit values with the "Automatic" slide button activated:

Transients	Limit value "Automatic"
Rapid overvoltage (absolute voltage)	110% of the momentary 200 ms RMS value
Voltage envelope	±5% of the nominal voltage
Voltage rapid increase	10% of the momentary 200 ms RMS value

i INFORMATION

Fundamental explanations of "events and transients" can be found in the document "Energy Supply Quality Characteristics – Power Quality Solutions from Janitza" and on www.janitza.com.

* ... **Hysteresis**

Difference between start and end limit value.

When measuring power quality, avoid hysteresis, because events are counted several times when the measured variable oscillates around the limit value. More information on events and transients can be found in the manual "Energy Supply Quality Characteristics – Power Quality Solutions from Janitza" and at www.janitza.com.

11.11.3 Event and transient recording

When an event or transient occurs, the measurement device records half waves (half cycles) and data points around the respective event/transient trigger (pulses which trigger events) - See Fig. *Event recording on the UMG 801*.

A distinction is made between lead time (pre-recordings) and lag time (post-recordings). These recordings occur at the start and end of an event or transient.

i INFORMATION

Events and transients must be configured for the UMG 801 in the GridVis® software. Information about configuration can be found in the program help and the online help for the software.

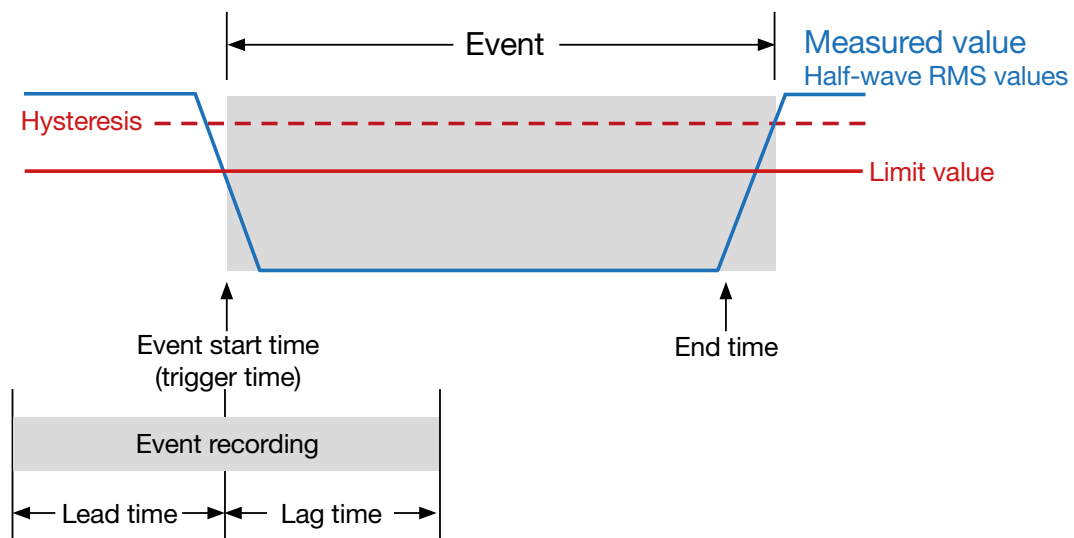

Fig. Event recording on the UMG 801

The event recording includes mean, minimum and maximum values along with the start and end time, and for longer events, the waveform at the beginning and end of an event as well.

11.11.4 Configuration of the waveform for events and transients

The recording length (lead time and lag time - see Fig. *Event recording on the UMG 801*) for events and transients can be configured in the **device configurator in the GridVis® software using the Recording menu under the item Waveform.**

Using the maximum sampling rate of 50 kHz, a



Fig. Waveform window with the configuration of the lead time and lag time in the Recording menu of the GridVis software - Configuration of the recording length.

recording length of max. 400 ms can be achieved, which captures **20,000 data points**. A longer recording length with the same number of data points reduces the sampling rate and thus the resolution of the event recording as shown in the following table:

Events and transients [Recording lengths]	Lead time	Lag time
Sampling rate 50 kHz (default setting)	100 ms	300 ms
Sampling rate 25 kHz -	200 ms	600 ms
Sampling rate 12.5 kHz -	400 ms	1200 ms
Sampling rate 6.25 kHz -	800 ms	2400 ms

Tab. Recording lengths at 20,000 data points for events and transients as a function of the sampling rate.

i INFORMATION

Detailed information on the configuration of events and transients can be found in the online help of the GridVis® software.

11.11.5 Half-wave RMS values for events

Within half waves (10 ms), the measurement device compares the measured value (RMS) with the limit value configured by the user (in the GridVis® software). If a measured value exceeds the limit value, the measurement device updates the event trigger (pulse that triggers an operation). The measurement device positions the event trigger at the beginning of a 10 ms window (start of the event).

Recording is then performed as described in Sect. "11.11.4 Configuration of the waveform for events and transients" on p. 80.

The event recordings of the half-wave RMS values are made at the following time intervals between the measured values:

Parameter/ Fault	Update time for the half-wave RMS values at f = 50 Hz 1)	Update time for the half-wave RMS values at f = 60 Hz 1)
Overcurrent	10 ms	8.33 ms
Fast voltage change	10 ms	8.33 ms
Voltage interruption	10 ms	8.33 ms
Overvoltage	10 ms	8.33 ms
Undervoltage	10 ms	8.33 ms
Frequency change	10 ms	8.33 ms
Overfrequency	10 ms	8.33 ms
Underfrequency	10 ms	8.33 ms

1) ... Period between the measured values.

11.11.6 Update time for transients

If a measured value exceeds the limit value configured in the GridVis® software, the measurement device detects a transient. When transients occur, the meter captures data points around the respective transient trigger.

Recording is performed as described in Sect. “11.11.4 Configuration of the waveform for events and transients” on p. 80.

The update time of the transient recording takes place at the following time intervals between the measured values - see the adjacent table:

Parameter/ Fault	Update time for the half-wave RMS values at $f = 50$ Hz ¹⁾	Update time for the half-wave RMS values at $f = 60$ Hz ¹⁾
Rapid overcurrent (absolute current)	39 μ s	39 μ s
Rapid overvoltage (absolute voltage)	19 μ s	19 μ s
Voltage (envelope)	19 μ s	19 μ s
Voltage (rapid increase)	19 μ s	19 μ s

1) ... Period between the measured values.

11.11.7 Event and transient configuration in the GridVis software

The GridVis software provides access to all parameters for configuring events and transients using the UMG 801 device configurator and the menus *Measurement* and *Recording*.

The screenshot displays the 'Device configurator' interface for a 'Basisgerät' (UMG 801). The 'Measurement' tab is active, and the 'Power Quality' configuration window is open. The window shows the following settings:

- Nominal value Main:** 230.0 V
- Event Settings:**
 - Over voltage Main: Threshold +10 % = 253.0 V, Hysteresis 2 % = 4.6 V
 - Under voltage Main: Threshold -10 % = 207.0 V, Hysteresis 2 % = 4.6 V
 - Voltage outage Main: Threshold -90 % = 23.0 V, Hysteresis 2 % = 4.6 V
 - Rapid voltage change Main: Threshold 5 % = 11.5 V, Hysteresis 2.5 % = 5.8 V
- Transient Settings:**
 - Absolute Main: Threshold +10 % = 253.0 V, Hysteresis Automatic
 - Envelope Main: Threshold 5 % = 11.5 V, Hysteresis Automatic
 - Slope Main: Threshold 10 % = 23.0 V, Hysteresis Automatic

Fig. Power quality window in the GridVis software for the configuration of events and transients.

11.11.8 Flicker

The measurement device requires the fundamental network values for the voltage and frequency-dependent measurement and calculation of the flicker values (**flicker measurement according to DIN EN61000-4-15:2011**).

The device user configures the fundamental network values (nominal values) in the device configurator in the GridVis software using the following entries:

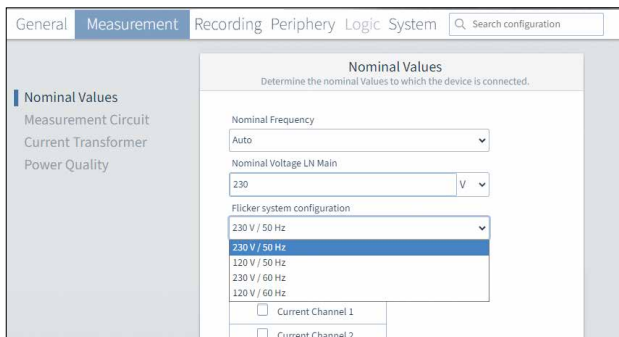

Fig. Nominal values window in the GridVis software with the configuration of the nominal values for the flicker measurement.

The measurement device records all flicker data, such as instantaneous, long-term and short-term flicker.

The flicker data is stored in the "Online values" and "Historical values" value tree windows of the GridVis software and can be displayed and evaluated by the device user as required using the graph function.

***i* INFORMATION**

Additional information on flickers can be found in the online help of the GridVis® software.

12. Digital inputs and outputs

As described previously in the chapter „9. PC connections and other interfaces“ on page 54, the device has 4 digital inputs and 4 digital outputs each.

You can configure the digital inputs and outputs easily and clearly in the GridVis® software. The GridVis® software is available for download from our website (www.janitza.com).

12.1 4 digital inputs

The digital inputs are used to send information from other devices with a digital output to your device (pulse counter).

In the “Peripherals” section of the “Configuration” window in the GridVis® software, an assistant guides you through the configuration of the 4 digital inputs with the following settings and functions:

1. **Value type selection list** (of the incoming signal, e.g. electrical energy, gas/water/oil consumption, CO₂, etc.)
2. **Name of the user-defined value** - Depends on the value type. Optional name entry for the value type “User-defined values”.
3. **Unit of user-defined value** - Depends on the value type. Optional entry of the unit for the value type “User-defined values”.
4. **Scaling factor** for the **pulse/unit** - The unit depends on the configured value type. If the value type “User-defined values” is set, the pulse/unit selection list adopts the unit entered under “Unit of user-defined value”.

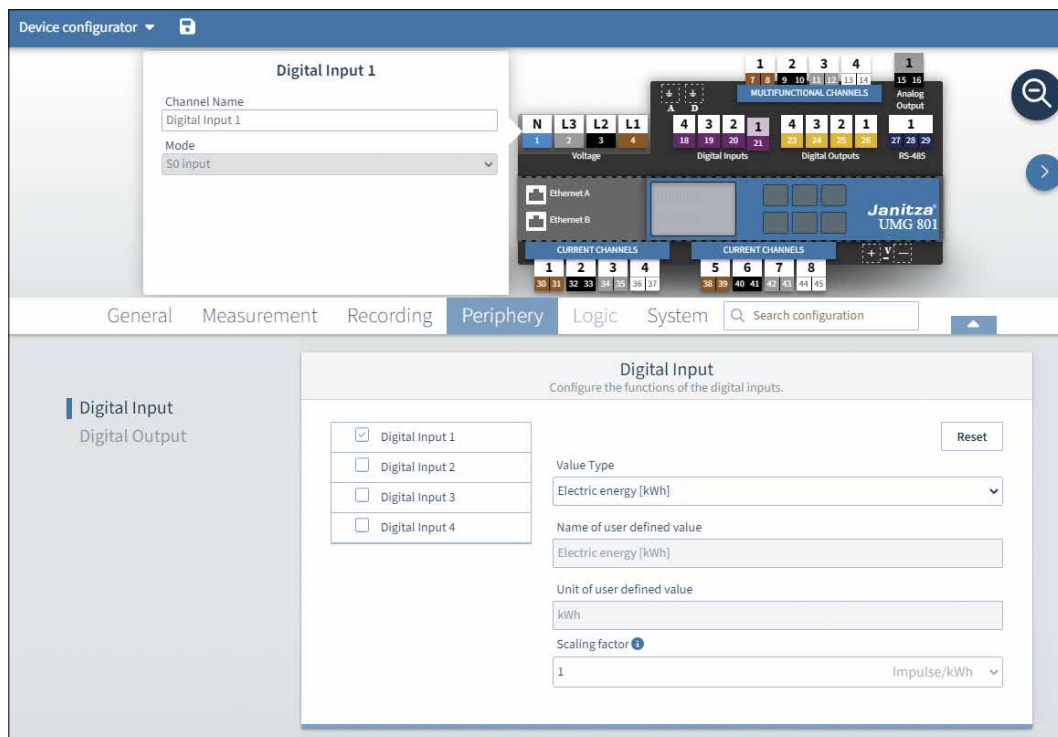

Fig. Assistant for configuring the digital inputs in the GridVis® software.

i INFORMATION

More information on configuring the digital inputs of your device can be found in the online help for the GridVis® software.

Configuration of the digital inputs as pulse counters

All digital inputs can be operated with a frequency of 20 Hz. The pulse duration (pulse width) and the pulse pause must be greater than 20 ms. The typical pulse duration for S0 pulses is 30 ms.

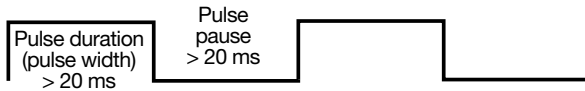

Pulse duration/pulse pause.

The maximum number of pulses per hour is calculated based on the minimum pulse duration and the minimum pulse pause:

Pulse duration (pulse width)	Pulse pause (pulse pause)	Max. pulses/h
20 ms	20 ms	90000 pul./h
30 ms	30 ms	60000 pul./h
50 ms	50 ms	36000 pul./h
100 ms	100 ms	18000 pul./h
500 ms	500 ms	3600 pul./h
1 s	1 s	1800 pul./h
10 s	10 s	180 pul./h

Examples of the maximum pulses per hour.

You configure the pulse counters with simultaneous measured-value or power calculation. The pulses are counted as a 64-bit number and the device has sufficient memory capacity for data acquisition.

Pulse valency

The pulse valency indicates what measured value or power value (e.g. energy) corresponds to a pulse. A pulse valency can be assigned to each digital input.

i INFORMATION

The pulse interval is proportional to the power within the selected settings.

Measured value calculation:

$$\text{Measured value} = \text{pulse} \times \text{pulse valency}$$

Power value calculation:

$$\text{Power value} = \frac{\text{Pulse} \times \text{pulse valency}}{\text{Time [s]}}$$

Since the pulse interval can be very large, continuous calculation of the measured or power values is not possible. Consequently, only average values are calculated. The calculation of the average values for the measured value calculation results from the number of pulses per period multiplied by the pulse valency. For the calculation of the mean power values, this value must be divided by a configurable time value.

The period is assigned to the respective digital input and can be set to between 1 and 60 minutes. After expiration of the period, the value can be accessed via the Modbus.

An external synchronization can be connected for each digital input, whereby one synchronization pulse completes a period and starts a new period. A capture time of 30 seconds is set for the external synchronization. If there is no synchronization pulse after the period has expired, the software takes over the synchronization after 30 seconds; also of the future periods.

Default setting for one period = 15 minutes

The calculation result of the S0 power value is available at the end of the period.

i INFORMATION

The programming in the GridVis® software shows a selection of energy values derived from the power values.

12.2 4 digital outputs

The 4 digital outputs of the device are used to produce pulses for counting the energy consumption. The current measuring channels of the basic device (or the selected module) are used as a reference in the form of measurement groups (measurement group 1 - I1 to I4, measurement group 2 - I5 to I8, measurement group 3 - multifunction channels).

In the “Peripherals” section of the “Configuration” window in the GridVis® software, an assistant guides you through the configuration of the 4 digital outputs with the following settings and functions:

1. **Segment selection list**
Selection of the device (basic device/modules).
2. **Measurement Group selection list** -
Selection of the measurement group of the respective device.
3. **Measured Value selection list** -
Selection of the measured value, e.g. active energy overall tariff, apparent energy overall tariff, reactive energy overall tariff, etc.
4. **Phase/Channel** -
Phase/channel whose pulse is used for the output.
5. **Pulse valency** -
See description for “Pulse output”.
6. **Pulse width (pulse duration)** -
See description „Pulse duration/pulse pause.“ on page 85.

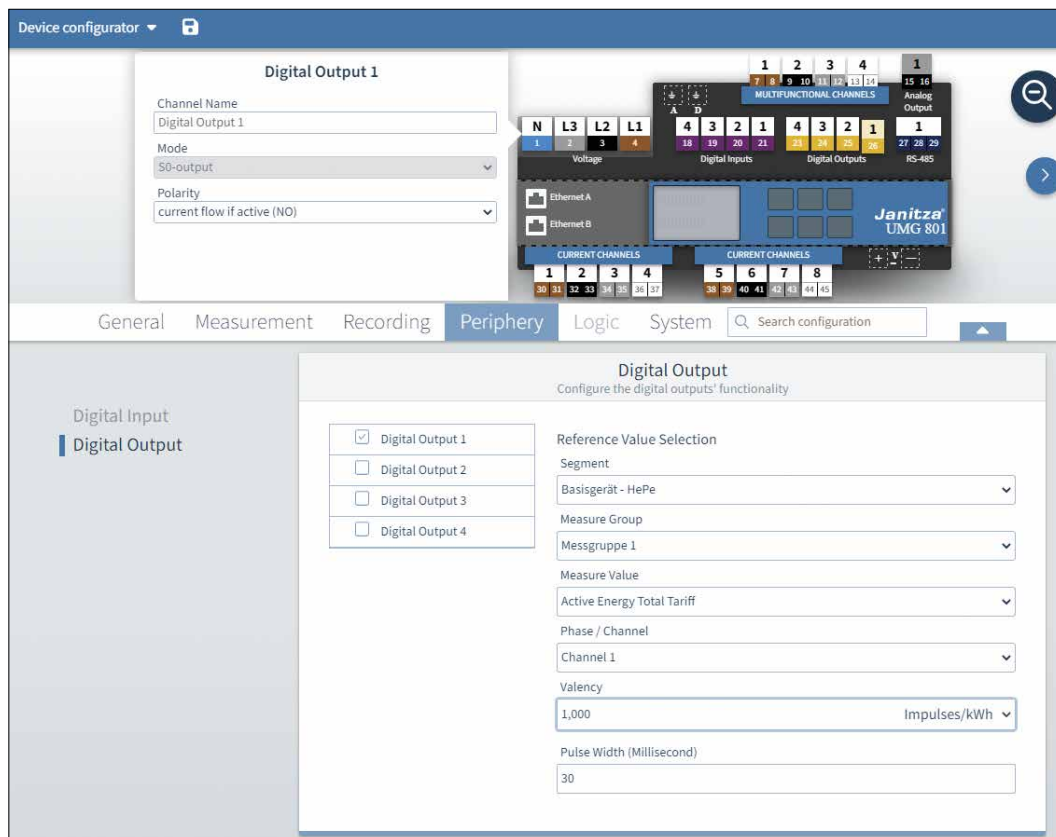

Assistant for configuring the digital outputs (GridVis® software)

i INFORMATION

For detailed information on configuring the digital outputs of your device, refer to the online help for the GridVis® software.

Pulse output

The digital outputs can be used to output pulses for counting the active energy, apparent energy and reactive energy. To do so, a pulse is generated at the output after a certain, configurable amount of energy has been reached.

To use a digital output as a pulse output, configure the corresponding settings in the configuration assistant of the GridVis® software:

- Output polarity: Normally open, normally closed
- Mode for the digital output: S0 output
- Pulse valency
- Pulse width

Pulse valency

The pulse valency indicates how much energy (Wh or varh) corresponds to one pulse.

The pulse valency is determined by the maximum connected load and the maximum number of pulses per hour.

If you indicate the pulse valency with:

- A positive sign, pulses are only output if the measured value also has a positive sign.
- A negative sign, pulses are only output if the measured value also has a negative sign.

i INFORMATION

Since the **Active energy meter** operates with a reverse running stop, the device only sends pulses when electrical energy is consumed.

Since the **Reactive energy meter** operates with a reverse running stop, the device only sends pulses when there is an inductive load.

1. Determining pulse valency

Set the pulse length according to the requirements of the connected pulse receiver. With a pulse duration of e.g. 30 ms, the device can emit a maximum number of 60000 pulses per hour (see table "Maximum pulses" on Page 85).

2. Determine maximum connected load

Example:

Current transformer = 150/5 A
Voltage L-N = max. 300 V

Power per phase = 150 A x 300 V
= 45 kW

Power with 3 phases = 45 kW x 3
Max. Connected load = 135 kW

3. Calculate pulse valency

$$\text{Pulse valency} = \frac{\text{Max. connected load}}{\text{Max. number of pulses/h}} \quad [\text{Wh/pulse}]$$

Pulse valency = 135 kW / 60000 pulses/h

Pulse valency = 0.00225 kWh/pulse

Pulse valency = 2.25 Wh/pulse

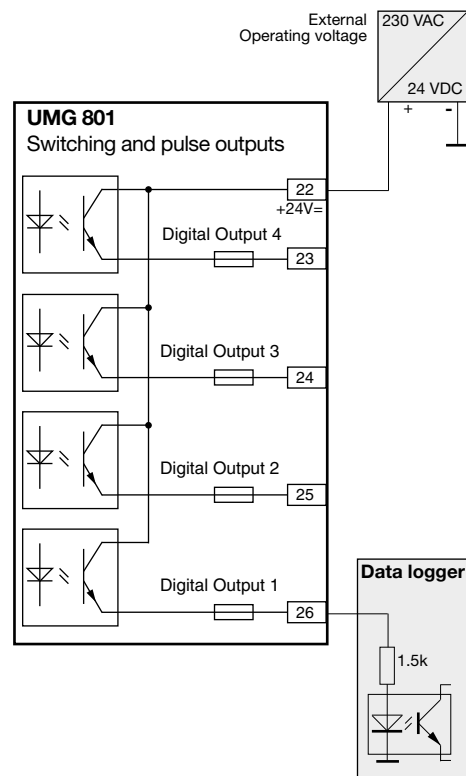

Connection example for wiring as a pulse output.

i INFORMATION

When using the digital outputs as pulse outputs, measurement errors can occur due to residual ripple. For the supply voltage (DC) of the digital inputs and outputs, use power supplies whose residual ripple is less than 5% of the supply voltage.

12.3 Comparator

To monitor limit values, the measurement device has **125 comparators** which the user can assign to **32 comparator groups** in the GridVis software.

After the "AND" or "OR" linking of the comparators in a comparator group, the result can be assigned to one of the 4 digital outputs of the measurement device.

Comparators and comparator groups can be configured in the configuration window of the measurement device in the GridVis software under Logic > Comparators:

i INFORMATION

In addition to selecting previously configured profiles for the comparators, you can also assign names for comparators and comparator groups in the GridVis® software.

Further information on configuring the comparators and comparator groups can be found in the online help for the GridVis® software.

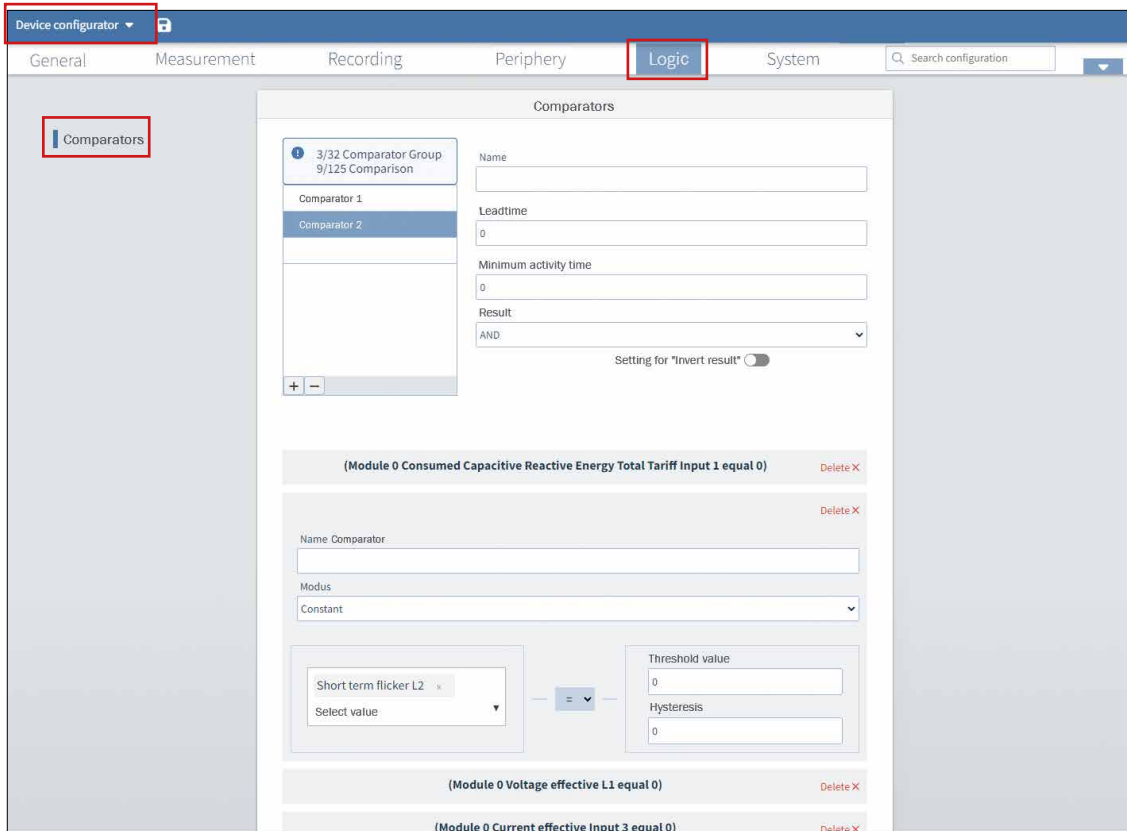

Fig. GridVis® software:
Configuration of the comparators and comparator groups in the configuration window of the measurement device

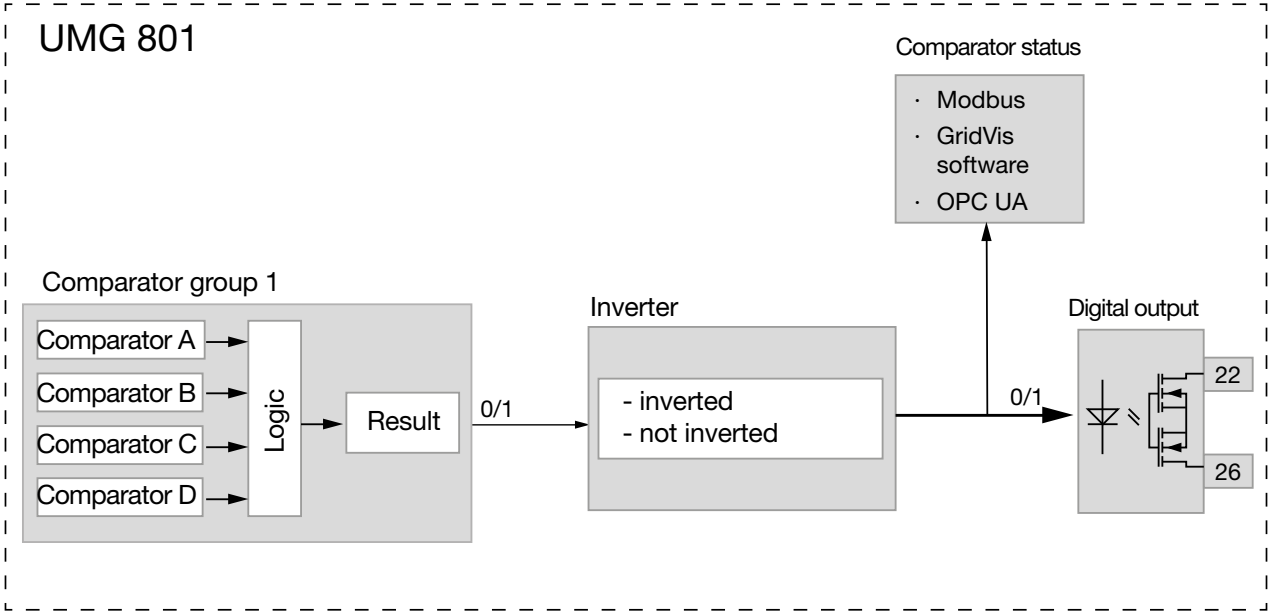

Fig. Application example: Block diagram "Using digital output 1 for limit value monitoring"

Comparator without hysteresis

- The set limit value is compared with the measured value.
- If there is a limit violation for at least the duration of the lead time, the comparator result is changed.
- The result is retained at least for the duration of the minimum activity time and at most for the duration of the limit violation. If there is no longer a limit violation and the minimum activity time has expired, the result is reset.

Comparator running time

The comparator running time is a time counter for each comparator that adds up the total time that the comparator output was set to active. This means that if the condition of the comparator is fulfilled and the lead time has expired, the counter increases by the corresponding amount of time. The minimum activity time (minimum initialization time) is taken into account here.

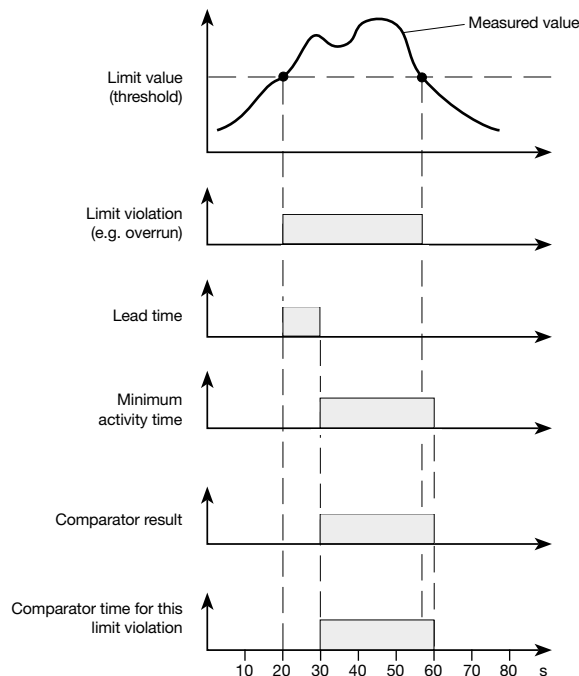

Fig. Comparator without hysteresis
Example with 10 s lead time and 30 s minimum activity time

Comparator with hysteresis

With the hysteresis in %, the switching off of the comparator can be delayed (as with an event).

Example: In the "above threshold" mode, the momentary measured value must again fall below the threshold value minus the hysteresis in order to change the output of the comparator.

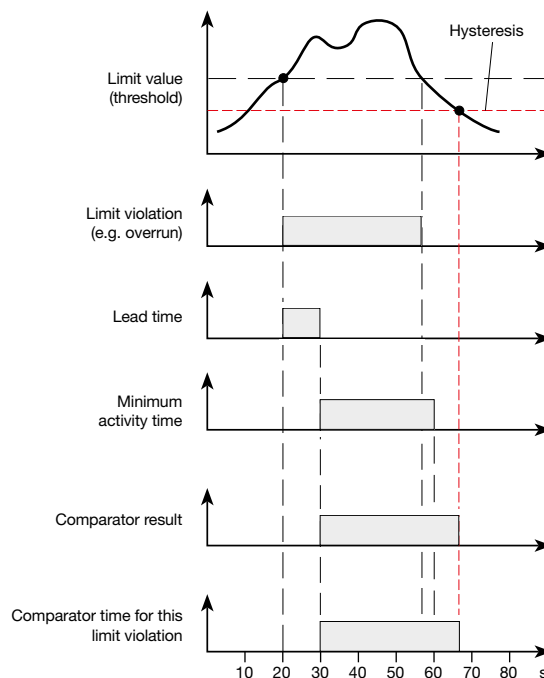

Fig. Comparator with hysteresis
Example with 10 s lead time and 30 s minimum activity time

13. Analog outputs

The device has an analog output which:

- Supplies a current of up to 20 mA.
- Requires an external 24 V DC power supply for operation.

After activating the analog output, an assistant in the “Peripherals” section of the “Configuration” window in the GridVis® software, guides you through the configuration with the following settings and functions:

1. **Segment selection list**
Selection of the device (basic device/modules).
2. **Measurement Group selection list** -
Selection of the measurement group of the respective device.
3. **Measured Value selection list** -
Selection of the measured value.
4. **Phase/Channel** -
Phase/channel whose pulse is used for the output.
5. **Type of measured value** -
See description of “Pulse output”.
6. **Output signal**
4 - 20 mA or 0 - 20 mA.
7. **Start value**
See “Principle of analog output examples”.
8. **End value**
See “Principle of analog output examples”.

Principle of analog output examples:

Monitoring of **voltage**

(output range 4 - 20 mA):

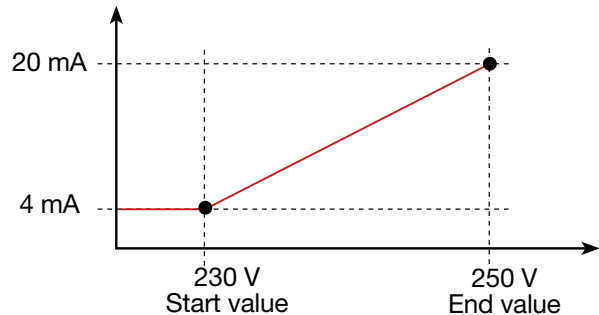

Allocation **active power L1**

(output range 4 - 20 mA):

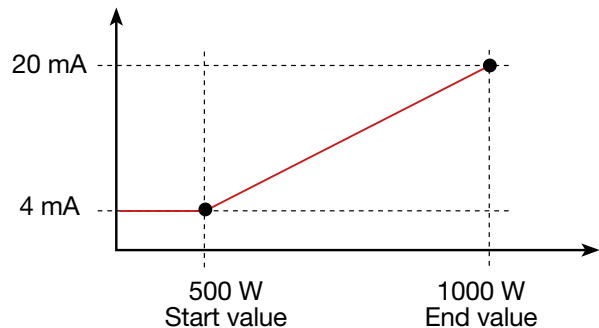

- With an active power of 500 W, the current at the analog output is 4 mA; with an active power of 1000 W --> 20 mA.
- The measured active power is proportional to the current at the analog output.

Allocation of the calculated **active power factor cos(math.)**

(output range 4 - 20 mA):

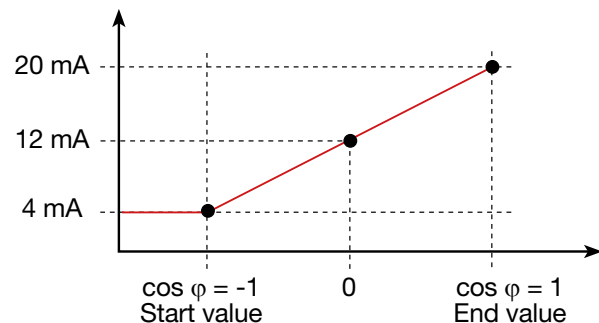

- Monitoring of the active power factor $\cos \varphi$ (math.) with:
 $\cos \varphi$ (math.) > 0 active power, consumed.
 $\cos \varphi$ (math.) < 0 active power, delivered.

Device configurator

Analogue Out Channel 1

Enable Channel

General Measurement Recording Periphery Logic System

Search configuration

Analogue Output

Configure the functions of the analog outputs.

Analogue out 1

Reference Value Selection

Segment
Basisgerät - HePe

Measure Group
Messgruppe 1

Measure Value
Current effective

Phase / Channel
Channel 1

Kind of measure value
Current value

Output signal
4 - 20 mA

Start value
0 A

End value
0 A

Assistant for configuration of the analog output (GridVis® software)

i INFORMATION

Information on configuring the analog output of your device can be found in the online help for the GridVis® software.

14. Commissioning

INFORMATION

Before commissioning, delete possible production-related contents of the energy meters, minimum and maximum values as well as recordings (for more details, see Sect. "11.9 Reset" on p. 75).

WARNING

Material damage due to disregard of the connection instructions!

Voltages and currents outside the permissible measuring range can destroy the device.

Comply with the measuring range specifications from the technical data.

14.1 Supply voltage

Proceed as follows when applying the supply voltage:

1. Connect the supply voltage to terminals 46 and 47 of the device. The proper supply voltage can be found on the rating plate or the Sect. "21. Technical specifications" on p. 134.
2. The standard display *Measured values* appears on the display.
3. If no display appears, check:
 - The connection of your device.
 - Whether the supply voltage is within the nominal voltage range.

INFORMATION

To connect the supply voltage, please observe all of the information in section „7.3 Supply voltage“ on page 35.

14.2 Measured voltage

Connect measured voltage:

1. Connect the measured voltage to the terminals provided for this purpose (see section „7.4 Voltage measurement“ on page 36).
2. After connecting the measured voltage, check the measured values displayed by the meter for the voltages L-N and L-L (take into account any voltage transformer factors that may have been set).

INFORMATION

- In networks which exceed the specified nominal voltages, connect the voltage measurement inputs via voltage transformers (see section „7.1 Nominal voltages“ on page 34)!
- The meter only measures if at least one voltage measurement input has an L-N voltage of $> 10 V_{\text{eff}}$ or an L-L voltage of $> 18 V_{\text{eff}}$ present.

WARNING

Risk of injury due to electrical voltage!

If the device is exposed to surge voltages above the permissible overvoltage category, safety-relevant areas of insulation in the device can be damaged. This means that the safety of the product can no longer be guaranteed.

Only use the device in environments in which the permissible overvoltage category is not exceeded (see chap. „21. Technical specifications“ on page 134).

14.3 Measured current

The device:

- Measures current exclusively via current transformers.
- Is designed for the connection of current transformers with secondary currents of $\dots/1$ A and $\dots/5$ A.
- Does not measure DC currents.
- Has current measurement inputs which can be loaded with 120 A (sinusoidal) for 1 second.

The factory-set current transformer ratio is 5/5 A and must be adapted to the current transformers used as needed.

The current transformers require a basic insulation according to IEC 61010-1:2010 for the nominal voltage of the circuit.

1. Short-circuit all current transformer outputs except one.
2. Compare the current displayed on the device with the applied input current.
 - The currents must match after taking the current transformer ratio into account.
 - In the short-circuited current measurement inputs, the device must indicate approx. 0 amperes.

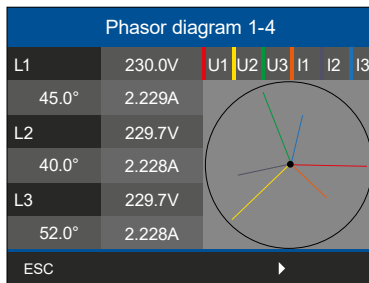
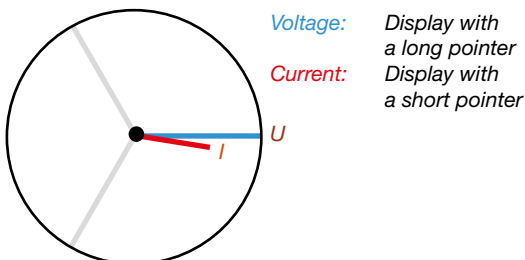

Fig. Phasor diagram

Sign of phase shift angle (U/I):

- Positive (+) with capacitive load.
- Negative (-) with inductive load.



i INFORMATION

For explanations concerning the phasor diagram, see chap. „14.6 Fundamentals on the phasor diagram“ on page 96.

14.4 Frequency measurement

For the measurement and calculation of measured values, the device requires the nominal or mains frequency. The mains frequency can either be specified by the user or determined automatically by the device.

- To determine the mains frequency, a voltage greater than $10 V_{\text{eff}}$ (4-conductor measurement) or a voltage L1-L2 greater than $18 V_{\text{eff}}$ (3-conductor measurement) must be applied to voltage measurement input V1.
- The mains frequency must be in the range from 40 Hz to 70 Hz.
- If the measured voltage is not sufficiently high, the device cannot determine the mains frequency and therefore cannot carry out a measurement.

14.5 Direction of rotary field

To determine the direction of the voltage rotating field, refer to the "Phasor diagram" display:

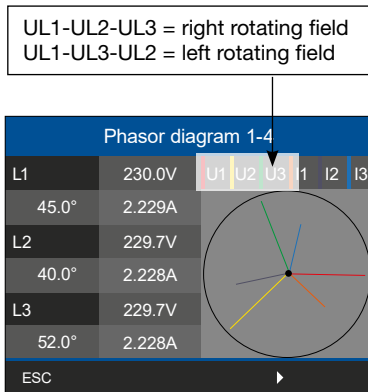

Fig. phasor diagram showing the phase sequence according to the direction of rotating field

- Press function button 1 *ESC* to open the menu.
- Use buttons 2 "▲" or 5 "▼" to select the menu item *Phasor diagram* and confirm with button 3 *Enter*.
- A submenu appears with the items *Phasor diagram 1-4* and *Phasor diagram 5-8*.

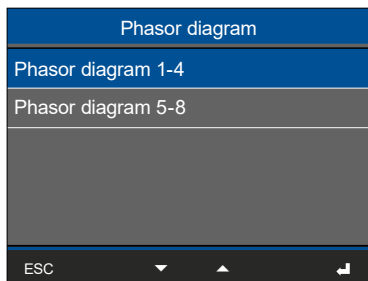

Fig. Submenu item Phasor diagram 1-4

- Use buttons 2 "▲" and 5 "▼" to select, for example, the menu item *Phasor diagram 1-4* and confirm with button 3 *Enter*.
- The *Phasor diagram 1-4* window appears.

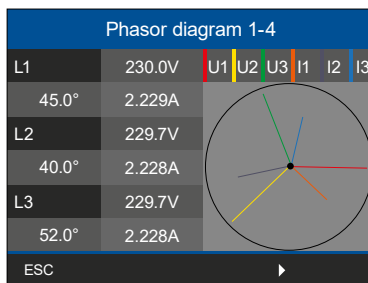

Fig. Window Phasor diagram 1-4

14.6 Fundamentals on the phasor diagram

The phasor diagram graphically describes the phase shift or phase angle between the voltage and the current. The phasors rotate at a constant angular speed – proportional to the frequency of the voltage and current – around an origin. The phasor diagram thus shows the momentary state of the variables in an AC circuit.

Representation of ohmic resistance:

- Voltage and current are in phase.

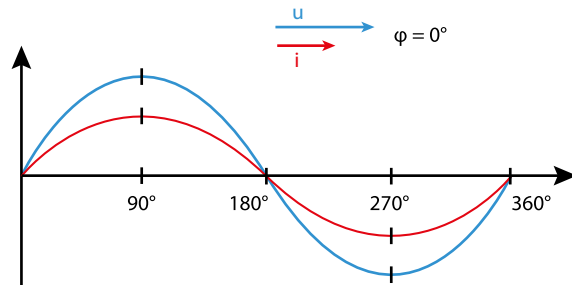

Representation of inductance:

- The voltage is ahead of the current.
- The phase shift for an "ideal coil" is 90°.

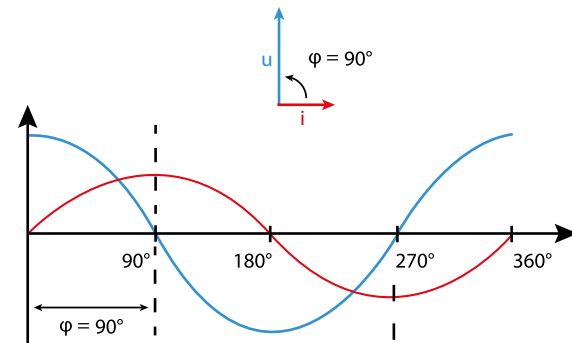

Representation of capacitance:

- The current is ahead of the voltage.
- The phase shift of an "ideal capacitor" is 90°.

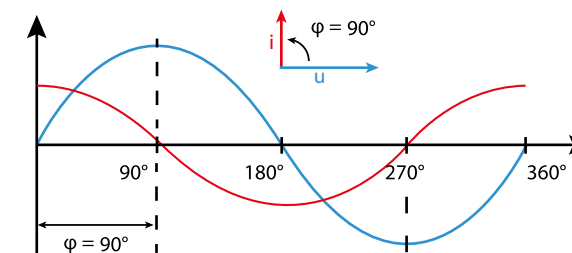

With a combination of the states, the phase angle “current to voltage” can assume values between -90° and $+90^\circ$.

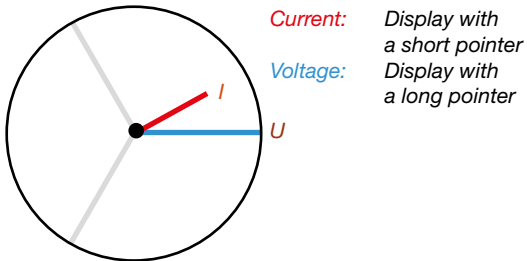

Example phasor diagram (3-phase)

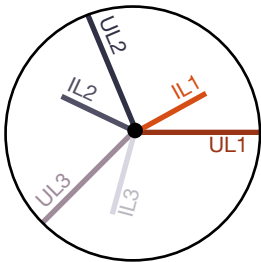

Current and voltage are shifted against each other. The current is ahead the voltage, i.e. the network is capacitively loaded.

14.7 Checking of voltage and current inputs by means of phasor diagram

The phasor diagram can be used to check incorrect connections at the voltage and current inputs.

Example 1

Primarily ohmic load.

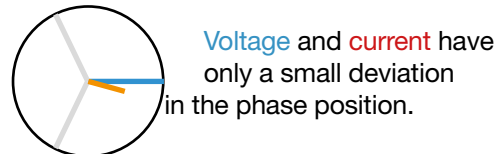

- The current measurement input is assigned to the correct voltage measurement input

Example 2

Primarily ohmic load.

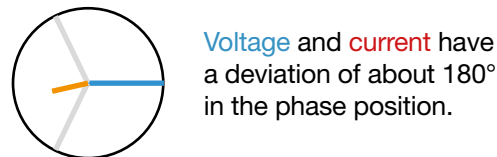

- The measured current input is assigned to the correct voltage measurement input.
- In the current measurement under consideration, the connections k and I are reversed or there is a feedback into the supply network.

14.8 Checking the phase assignment

The assignment of the phase conductor to the current transformer is correct if a current transformer is short-circuited on the secondary side and the current indicated by the device in the associated phase conductor drops to 0 A.

14.9 Checking the power measurement

1. Short-circuit all current transformer outputs except one and check the indicated powers.
2. The device must only display power in the phase conductor with the current transformer output that is not short-circuited.
3. If this is not the case, check the connections of the measured voltage and the measured current.

If the amount of the measured active power is correct, but the sign is negative, this can have 2 causes:

1. Reversed connections S1(k) and S2(l) at current transformer or
2. Active energy is being delivered back into the grid.

14.10 Checking measurement

Correctly connected voltage and current measurement inputs result in correctly calculated and displayed individual and summation power readings.

14.11 Checking individual power

If a current transformer is assigned to the wrong phase, the corresponding power will be measured and displayed incorrectly.

The phase conductor and current transformer are correctly assigned on the device if there is no voltage between the phase conductor and the associated current transformer (primary).

To ensure that a phase conductor at the voltage measurement input is assigned to the correct current transformer for the power measurement, the respective current transformer can be short-circuited on the secondary side. The apparent power displayed by the device must then be zero in this phase conductor.

If the apparent power is displayed correctly but the active power has a negative (“-”) sign, then the current transformer terminals are reversed or power is being supplied to the electric utility.

14.12 Checking summation power

If the meter correctly measures and displays all voltages, currents and powers for the respective phase conductors, the summation powers measured by the device are also correct.

To check the measurement device’s summation powers, compare the measurement device’s measured energy values with the energy readings of the active and reactive energy meters in the feeder.

14.13 Drag indicator function

The "drag indicator" function of the measurement device records the 3 highest average values of measured value types over a defined time base (interval).

- A parameter with a time stamp in the GridVis® software provides the recorded average values.
- The time base and synchronization mode must be configured in the GridVis® software.
- The average value is calculated from the measured value types:
 - Current L1
 - Current L2
 - Current L3
 - Active power L1
 - Active power L2
 - Active power L3
 - Active power sum (L1...L3)
 - Apparent power L1
 - Apparent power L2
 - Apparent power L3
 - Apparent power sum (L1...L3)

Time base:

Time base in seconds - interval during which the measurement device calculates average values (duration of measured value recording). With internal synchronization, the average values are recalculated after the configured time base has elapsed.

Synchronization mode:

The synchronization mode determines the start time for the calculation periods of the average values. Synchronization modes:

1. Only internal drag indicator synchronization via the internal measurement device clock.
2. External drag indicator synchronization by a rising or falling edge at digital input 4.
3. External drag indicator synchronization via Modbus.

The time base and drag indicator synchronization must be configured in the GridVis software!

The "**Time base**" input field and the "**Synchronization mode**" selection field can be found in the device configurator window of your measurement device on the "General" tab in the GridVis® software.

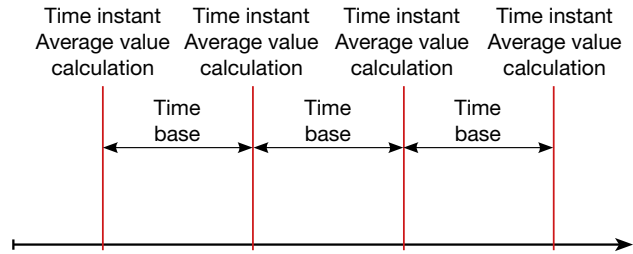

Fig.: Principle of synchronization

14.13.1 Configuring the drag indicator synchronization

The synchronization determines a start time for the calculation periods of the drag indicator average values (averaging intervals).

The measurement device has **3 methods** for drag indicator synchronization. One method is considered to be internal synchronization and two methods are considered external synchronization.

1. Internal synchronization only

With the configuration "**Internal synchronization only**", the drag indicator synchronization takes place via the internal measurement device clock.

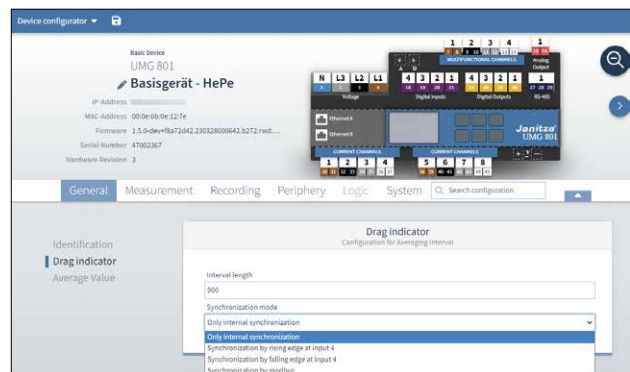

Synchronization mode "Internal synchronization only" with the time base 900 s (15 m) in the GridVis® software

2. External synchronization - synchronization by rising or falling edge at digital input 4

With the configuration "**Synchronization by rising edge at digital input 4**" or "**Synchronization by falling edge at digital input 4**", the drag indicator synchronization takes place with the rising or falling edge of an input pulse (external pulse) at digital input 4.

Prerequisite for external synchronization:
Before you select the "**Time base**" and the "**Synchronization mode**", configure the "**Drag indicator synchronization**" mode for digital input 4 in the device configurator window of your measurement device on the "**Periphery**" tab.

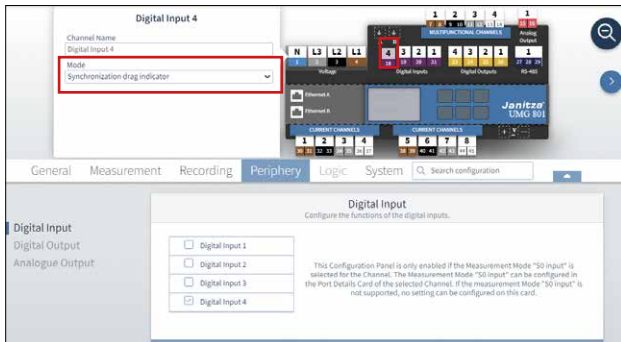

GridVis software: Configuration of the "Drag indicator synchronization" mode

Then select the synchronization mode "**Synchronization by rising or falling edge at input 4**" in the configuration window of the "**General**" tab

Rising edge

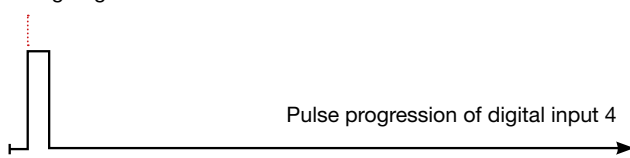

Fig.: Principle of the pulse sequence at digital input 4 - rising edge

Falling edge

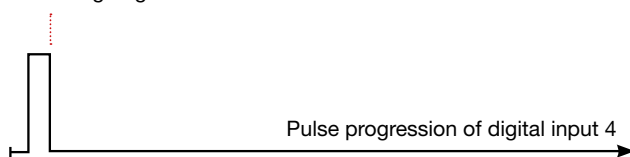
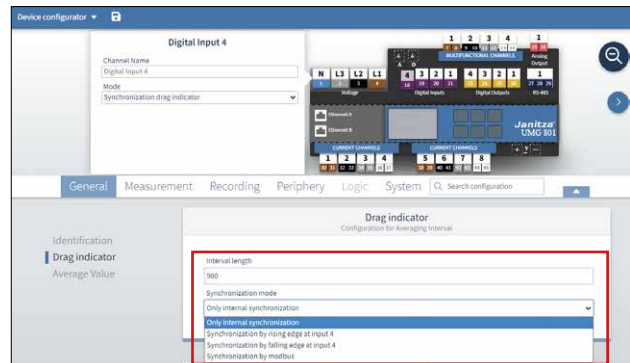

Fig.: Principle of the pulse sequence at digital input 4 - falling edge



Synchronization mode "Synchronization by rising or falling edge at digital input 4" with the time base 900 s (15 m) in the GridVis® software

3. External synchronization - Synchronization via Modbus

With the configuration "**Synchronization via Modbus**", the drag indicator synchronization takes place via an external Modbus command.

In the configuration window of the "**General**" tab, select the synchronization mode "**Synchronization via Modbus**".

14.13.2 Drag indicator - measurement device display

As already described in the section „Drag indicator function“ on page 99, the drag indicator function shows the **3 highest average values of value types over a defined period (time base)**.

The drag indicators of the respective measured value types can be found on the measurement device display under *Menu > Drag indicator*. Proceed as follows:

- If you are not in the start screen, you can go to this view by pressing button 3 (*Home*).
- Open the menu using button 1 (*ESC*).
- Use buttons 2 (\blacktriangledown) and 5 (\blacktriangle) to select the item *Drag indicator* and confirm with button 6 (*Enter*).

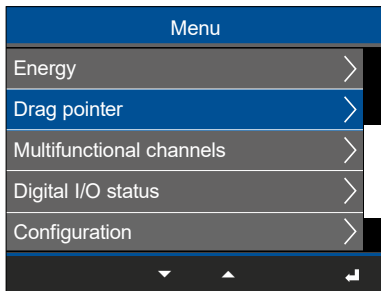

Drag indicator menu item

- The *Drag indicator* submenu appears with the items *Basic device 1-4 (measurement group 1)* and *5-8 (measurement group 2)*.

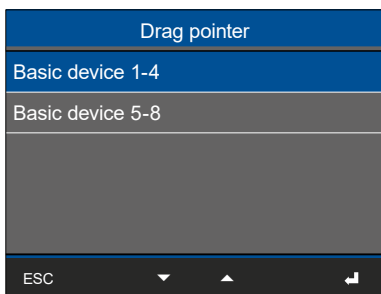

Drag indicator submenu

- Use buttons 2 (\blacktriangledown) and 5 (\blacktriangle) to select the item *Basic device 1-4* and confirm with button 3 (*Enter*).
- The *Drag indicator I #1* window appears with the measured values for current in phases 1 - 3 of the 1st rank (the highest values), plus the sum and the time stamp:

Drag pointer I #1		Basic device 1-4	
	Value	Date & Time	
1	2.200A	27.02.2023	11:38
2	1.100A	27.02.2023	11:38
3	3.100A	27.02.2023	11:38
Σ	6.400A	27.02.2023	11:38
ESC			

Drag indicator I (current) #1 - highest drag indicator measured value for the current in phases 1-3 plus the sum and the respective time stamp.

- Use buttons 2 (\blacktriangle) and 5 (\blacktriangledown) to navigate to additional drag indicator measured values (with sum and time stamp), each ordered by ranks (#) (up to 3 ranks) as follows:

1. Current I #1 (phase 1-3, + sum), time stamp 1
2. Current I #2 (phase 1-3, + sum), time stamp 2
3. Current I #3 (phase 1-3, + sum), time stamp 3

1. Consumed active power P+ #1 (phase 1-3, + sum), time stamp 1.
2. Consumed active power P+ #2 (phase 1-3, + sum), time stamp 2.
3. Consumed active power P+ #3 (phase 1-3, + sum), time stamp 3.

1. Delivered active power P- #1 (phase 1-3, + sum), time stamp 1
2. Delivered active power P- #2 (phase 1-3, + sum), time stamp 2
3. Delivered active power P- #3 (phase 1-3, + sum), time stamp 3

1. Apparent power S #1 (phase 1-3), time stamp 1
2. Apparent power S #2 (phase 1-3), time stamp 2
3. Apparent power S #3 (phase 1-3), time stamp 3

- Use buttons 4 (\blacktriangleleft) and 6 (\blacktriangleright) to go to the drag indicator measured values of measurement group 2 (basic device 5-8).

More information on navigation can be found in Sect. “15. Overview of measured value and meter displays” on p. 104.

14.13.3 Resetting the drag indicator

Use the menu Configuration > Reset > Min./Max./Avg. to reset the minimum, maximum and average values as well as the drag indicator values.

Reset	
Factory settings	No
Configuration	No
Min./Max./Avg.	No
Energy	No
Historical data	No
ESC	

Fig. Reset window -> Min./Max./Avg. values item

i INFORMATION

- Before commissioning, delete any production-related contents of the energy meters, minimum, maximum and average values, drag indicators and recordings!
- Resetting current, active power or apparent power drag indicator values of one phase also causes a reset of the drag indicator values for the other phases of the respective category. If, for example, you reset the "Current" drag indicator of phase L1, the device also resets the "Current" drag indicators for phases L2 and L3!

Drag pointer I #1	Basic device 1-4	
	Value	Date & Time
1	0.000A	---
2	0.000A	---
3	0.000A	---
Σ	0.00A	---
ESC		

Fig. Window with reset drag indicators I (current) #1 (inputs 1 - 4)

14.14 Average value - gridded and moving

The measurement device records average values for the measured voltages, currents, powers and temperatures.

Use the **GridVis® software (in the device configurator under General > Average value)** to define the averaging interval (time base) for determining the average value of the respective measured values. The average values and the associated minimum and maximum values can be read out via Modbus addresses or OPC-UA.

i INFORMATION

- The measurement device
- overwrites the average values and the associated minimum and maximum values with each interval.
 - records the time stamp (time and date) for the gridded and moving averages in addition to the measured values.
 - The GridVis® software provides an option for selecting defined or user-defined recording sets with the averaging interval and the measured value calculation. Detailed information on this can be found in the online help for the GridVis® software.

14.14.1 Gridded average value

The measurement device calculates gridded averages for a fixed time base (averaging interval).

If the measurement device is set to 15 minutes, the averaging intervals always start at the full hour, a quarter of an hour after, at the half hour and a quarter of an hour before the full hour.

i INFORMATION

- **The measurement device records gridded average values as of Modbus address 5000.**
- **The default setting for the time base (averaging interval) in the GridVis® software is 10 min.**

Gridded averages allow you to compare the time periods from several measurement devices that are synchronized.

Example of a 15 min. averaging interval:

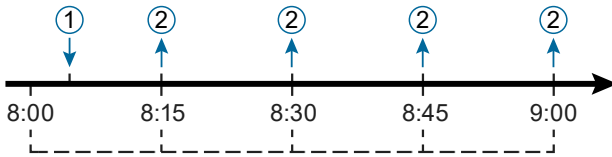

Fig. Gridded averages - averaging interval = 15 min.:
1) Switch on (start measurement); 2) New average value from the previous 15 min. interval available

14.14.2 Moving average value

Moving averages always apply to the last elapsed time interval (averaging interval), starting from the current time.

The time interval for determining the mean value must be defined in the GridVis® software. The measurement device recalculates the average values every minute.

The averaging interval for moving averages is configured to 10 min. in the measurement device default settings.

Example - Moving average with an averaging interval of 15 min:

The measurement device is switched on at 10:05 and from this time on it continuously generates new average values for the previous 15 min.

The measurement device

- has the average value for 10:05-10:20 a.m at 10:20 a.m.
- has the average value for 10:06-10:21 a.m at 10:21 a.m.
- etc.

14.14.3 Gridded and moving average in the GridVis® software

As already mentioned in section 14.14, the averaging interval (time base) and the type of averaging must be configured in the device configurator of the Grid-Vis software under General > Averaging.

There are 4 options for calculating the measured value (averaging), which mean the following:

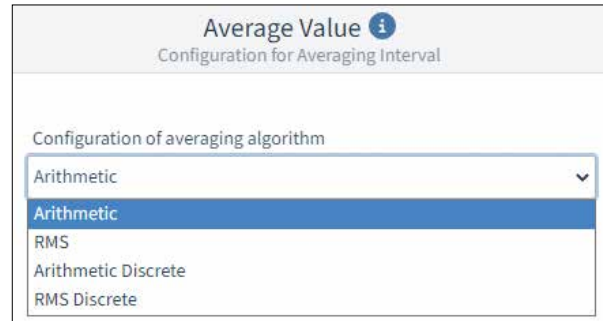

Configuration of the averaging in the GridVis® software (Type of averaging - Calculation of average values)

Averaging	Calculation
Arithmetic	Moving, arithmetic averaging.
RMS	Moving RMS (RMS ... root mean square).
Arithmetic Discrete	Gridded, arithmetic averaging.
RMS Discrete	Gridded, RMS averaging.

Tab. Configuration options for the averaging and calculating it

15. Overview of measured value and meter displays

i INFORMATION

The following measured-value and meter displays do not show a specific application and may differ depending on the connection of your measurement device and the measuring environment, e.g. for measurements in 3 or 4-conductor networks (TN, TT and IT networks) or with connected current measuring modules, etc.

Menu (Home)

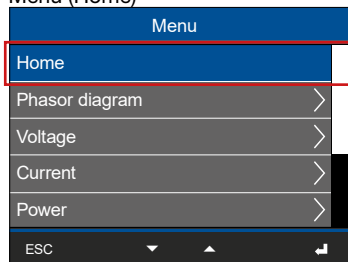

Network analysis (Start screen)

Home			
	Voltage	Current	Power
L1	230 V	1.45 A	0.333 kW
L2	234 V	2.77 A	0.649 kW
L3	233 V	1.32 A	0.308 kW
Σ	50.00Hz	5,54 A	1,290 kW

Display of voltage L1, L2, L3; frequency; current L1, L2, L3, sum; power L1, L2, L3, sum.

Menu (phasor diagram)

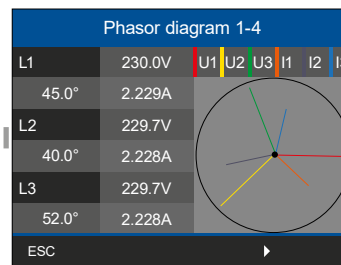
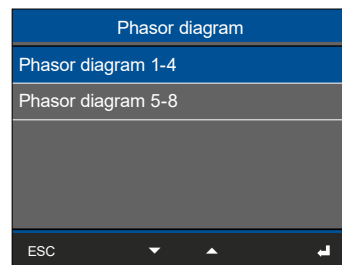
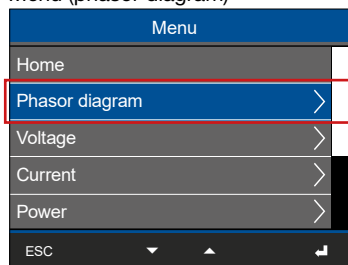

Display: Voltage L1, L2, L3; current L1, L2, L3; phase shift between voltage and current L1, L2, L3.

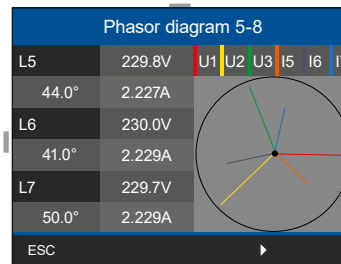
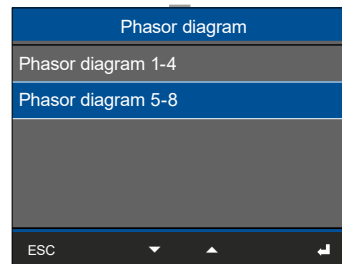

Display: Voltage L5, L6, L7; current L5, L6, L7; phase shift between voltage and current L5, L6, L7.

i INFORMATION

Depending on the measurement (4-conductor or 3-conductor measurement), the phasor diagrams (TN/TT network and IT network) will differ!

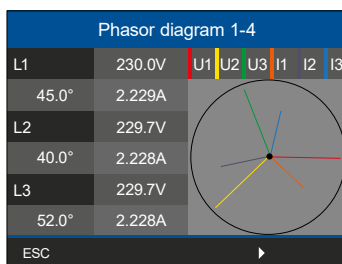

Fig. "Phasor diagram" of the 4-wire measurement (e.g. TN or TT network)

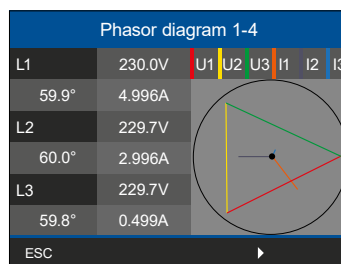

Fig. "Phasor diagram" of a 3-conductor measurement (IT network - ungrounded system)

Menu (Voltage)

Menu	
Home	
Zeigerdiagramm	>
Spannung	>
Strom	>
Leistung	>
▼ ▲ ↵	



i INFORMATION

Total harmonic distortion (THD) shows the percentage of non-linear distortion in an electrical signal in % (comparison of the RMS value of all harmonics currents to the RMS value of the fundamental oscillation). THD-U is the distortion of the voltage and THD-I is the distortion of the current.

Menu (Current)

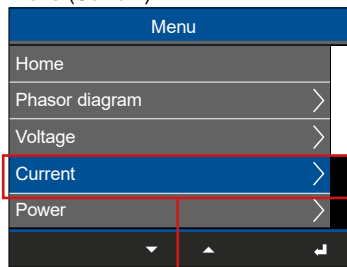

Submenu (Current)

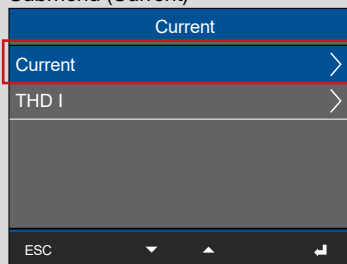

Current

- Basic device 1-4
- Basic device 5-8

ESC

Current		Basic device 1-4		
	Value	Avg.	Max.	
1	1.940A	1.940A	1.940A	
2	1.940A	1.940A	1.940A	
3	1.940A	1.940A	1.940A	
4	0.001A	0.001A	0.001A	

ESC

Display "Current (1-4)" L1, L2, L3, L4 with mean and maximum values.

Current

- Basic device 1-4
- Basic device 5-8**

ESC

Current		Basic device 5-8		
	Value	Avg.	Max.	
5	1.930A	1.930A	1.930A	
6	1.930A	1.930A	1.930A	
7	1.930A	1.930A	1.930A	
8	0.001A	0.001A	0.001A	

ESC

Display "Current (5-8)" L5, L6, L7, L8 with mean and maximum values.

Submenu (THD-I)

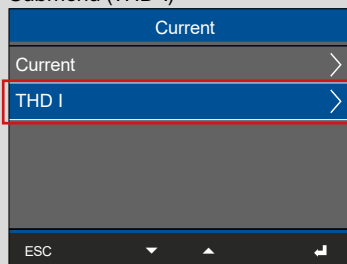

THD-I

- Basic device 1-4
- Basic device 5-8

ESC

THD I		Basic device 1-4		
	Value	Avg.	Max.	
1	166.3%	166.3%	166.3%	
2	166.4%	166.4%	166.4%	
3	166.4%	166.4%	166.4%	
4	201.1%	207.0%	222.2%	

ESC

Display "THD-I (1-4)" - L1, L2, L3, L4 (Total Harmonic Distortion of the current in %) with average and maximum values.

THD-I

- Basic device 1-4
- Basic device 5-8**

ESC

THD I		Basic device 5-8		
	Value	Avg.	Max.	
5	166.3%	166.3%	166.3%	
6	166.4%	166.4%	166.4%	
7	166.4%	166.4%	166.4%	
8	209.3%	212.3%	227.6%	

ESC

Display "THD-I (5-8)" - L5, L6, L7, L8 with mean and maximum values.

Menu (Power)

Menu	
Home	
Phasor diagram	>
Voltage	>
Current	>
Power	>
	▼ ▲ ▾

Submenu (Power summary)

Power	
Power summary	>
Active power	>
Reactive power	>
Apparent power	>
Power factor	>
ESC	▼ ▲ ▾

Power summary	
Basic device 1-4	
Basic device 5-8	
ESC	▼ ▲ ▾

Power summary		Basic device 1-4	
	P	Q	S
1	0.10kW	-0.00kvar	0.19kVA
2	0.10kW	-0.00kvar	0.19kVA
3	0.10kW	-0.00kvar	0.19kVA
Σ	0.31kW	-0.00kvar	0.58kVA
ESC	▼ ▲ ▾		

Display "Summary of active, reactive and apparent power" for L1, L2, L3 and their sum.

Power summary	
Basic device 1-4	
Basic device 5-8	
ESC	▼ ▲ ▾

Power summary		Basic device 5-8	
	P	Q	S
5	0.11kW	-0.00kvar	0.20kVA
6	0.11kW	-0.00kvar	0.20kVA
7	0.11kW	-0.00kvar	0.20kVA
Σ	0.34kW	-0.00kvar	0.61kVA
ESC	◀ ▼ ▲		

Display "Summary of active, reactive and apparent power" for L5, L6, L7 and their sum.

Submenu (Active power)

Power	
Power summary	>
Active power	>
Reactive power	>
Apparent power	>
Power factor	>
ESC	▼ ▲ ▾

Active power	
Basic device 1-4	
Basic device 5-8	
ESC	▼ ▲ ▾

Active power		Basic device 1-4	
	Value	Avg.	
1	0.10kW	0.10kW	
2	0.10kW	0.10kW	
3	0.10kW	0.10kW	
Σ	0.31kW	0.31kW	
ESC	▼ ▲ ▾		

Display "Active power 1-4" for L1, L2, L3 with average values and sums.

Active power	
Basic device 1-4	
Basic device 5-8	
ESC	▼ ▲ ▾

Active power		Basic device 5-8	
	Value	Avg.	
5	0.11kW	0.11kW	
6	0.11kW	0.11kW	
7	0.11kW	0.11kW	
Σ	0.34kW	0.34kW	
ESC	◀ ▼ ▲		

Display "Active power 5-8" for L5, L6, L7 with average values and sums.

Submenu (Reactive power)

Power	
Power summary	>
Active power	>
Reactive power	>
Apparent power	>
Power factor	>
ESC	▼ ▲ ▾

Reactive power	
Basic device 1-4	
Basic device 5-8	
ESC	▼ ▲ ▾

Reactive power		Basic device 1-4	
	Value	Avg.	
1	-0.02kvar	-0.01kvar	
2	-0.02kvar	-0.01kvar	
3	-0.02kvar	-0.01kvar	
Σ	-0.06kvar	-0.02kvar	
ESC	▼ ▲ ▾		

Display "Reactive power 1-4" for L1, L2, L3 with average values and sums.

⋮

Reactive power	
Basic device 1-4	
Basic device 5-8	
ESC	▼ ▲ ▾

Reactive power		Basic device 5-8	
	Value	Avg.	
5	-0.02kvar	-0.01kvar	
6	-0.02kvar	-0.01kvar	
7	-0.02kvar	-0.01kvar	
Σ	-0.06kvar	-0.03kvar	
ESC	▼ ▲ ▾		

Display "Reactive power 5-8" for L5, L6, L7 with average values and sums.

Submenu (Apparent power)

Power	
Power summary	>
Active power	>
Reactive power	>
Apparent power	>
Power factor	>
ESC	▼ ▲ ▾

Apparent power	
Basic device 1-4	
Basic device 5-8	
ESC	▼ ▲ ▾

Apparent power		Basic device 1-4	
	Value	Avg.	
1	0.19kVA	0.16kVA	
2	0.19kVA	0.16kVA	
3	0.19kVA	0.16kVA	
Σ	0.58kVA	0.48kVA	
ESC	▼ ▲ ▾		

Display "Apparent power 1-4" for L1, L2, L3 with average values and totals.

⋮

Apparent power	
Basic device 1-4	
Basic device 5-8	
ESC	▼ ▲ ▾

Apparent power		Basic device 5-8	
	Value	Avg.	
5	0.20kVA	0.17kVA	
6	0.20kVA	0.17kVA	
7	0.20kVA	0.17kVA	
Σ	0.61kVA	0.50kVA	
ESC	▼ ▲ ▾		

Display "Apparent power 5-8" for L5, L6, L7 with average values and sums.

Submenu (Power factor)

Power	
Power summary	>
Active power	>
Reactive power	>
Apparent power	>
Power factor	>
ESC	▲ ▼ ▾ ▸

Power factor	
Basic device 1-4	
Basic device 5-8	
ESC	▼ ▲ ▾ ▸

Power factor		Basic device 1-4
cos(phi)		Power factor
1	0.984	0.513
2	0.985	0.513
3	0.985	0.513
Σ	0.985	0.981
ESC	▼ ▲ ▾ ▸	

Display "Power factor 1-4" for L1, L2, L3 with cos(phi) and sums.

Power factor	
Basic device 1-4	
Basic device 5-8	
ESC	▼ ▲ ▾ ▸

Power factor		Basic device 5-8
cos(phi)		Power factor
5	0.985	0.513
6	0.985	0.513
7	0.985	0.513
Σ	0.985	0.981
ESC	◀ ▼ ▲ ▸	

Display "Power factor 5-8" for L5, L6, L7 with cos(phi) and sums.

Menu (Energy)

Menu	
Power	>
Energy	>
Drag pointer	>
Multifunctional channels	>
Digital I/O status	>
ESC	▼ ▲ ▾ ▸

Submenu (Active energy)

Energy	
Active energy	>
Reactive energy	>
Apparent energy	>
ESC	▼ ▲ ▾ ▸

Active energy	
Basic device 1-4	
Basic device 5-8	
ESC	▼ ▲ ▾ ▸

Active energy		Basic device 1-4
Sum L1..L3		
Consumed	1.0kWh	
Delivered	1.0kWh	
ESC	▼ ▲ ▾ ▸	

Display "Active energy 1-4", sum L1..L3, consumed and delivered.

Active energy	
Basic device 1-4	
Basic device 5-8	
ESC	▼ ▲ ▾ ▸

Active energy		Basic device 5-8
Sum L1..L3		
Consumed	0.8kWh	
Delivered	0.8kWh	
ESC	◀ ▼ ▲ ▸	

Display "Active energy 5-8", sum L1..L3, consumed and delivered.

Submenu (Reactive energy)

Energy	
Active energy	>
Reactive energy	>
Apparent energy	>
ESC	

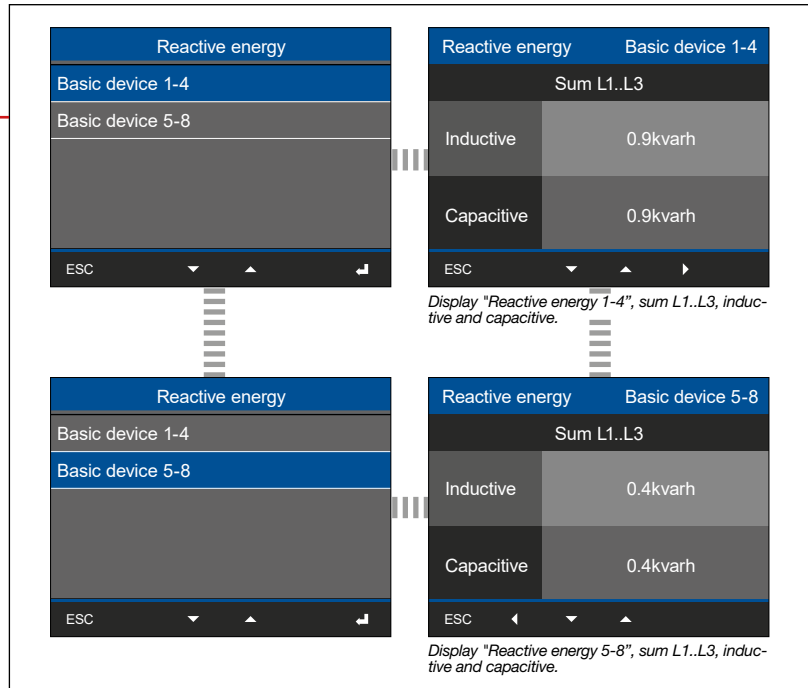

Submenu (Apparent energy)

Energy	
Active energy	>
Reactive energy	>
Apparent energy	>
ESC	

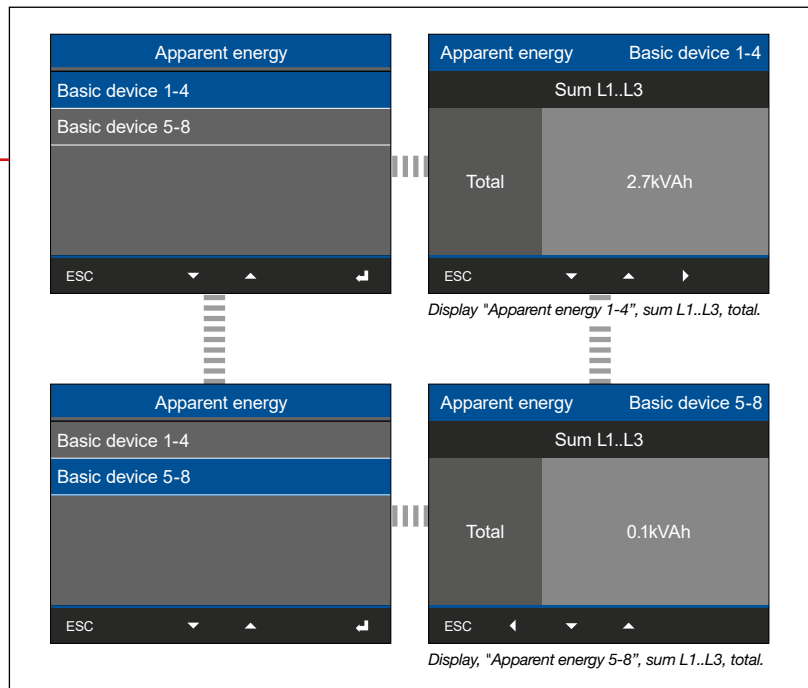

Menu (drag indicator)

Menu	
Energy	>
Drag pointer	>
Multifunctional channels	>
Digital I/O status	>
Configuration	>

Submenu (basic device 1-4)

Drag pointer	
Basic device 1-4	>
Basic device 5-8	>

Drag indicator current "I"

Drag pointer I #1		Basic device 1-4		Date & Time		Drag pointer I #3		Basic device 1-4		Date & Time	
	Value		Date & Time								
1	2.200A	27.02.2023	11:38	27.02.2023	11:43	27.02.2023	11:43	27.02.2023	11:48	27.02.2023	11:48
2	1.100A	27.02.2023	11:38	27.02.2023	11:43	27.02.2023	11:43	27.02.2023	11:48	27.02.2023	11:48
3	3.100A	27.02.2023	11:38	27.02.2023	11:43	27.02.2023	11:43	▲	▶		
Σ	6.400A	27.02.2023	11:38	▲	▶						

Display, Drag indicator I #1-#3 of the basic device 1-4

Drag indicator for consumed active power "P+"

Drag pointer P+ #1		Basic device 1-4		Date & Time		Drag pointer P+ #2		Basic device 1-4		Date & Time		Drag pointer P+ #3		Basic device 1-4		Date & Time	
	Value		Date & Time														
1	1.22kW	27.02.2023	11:38	27.02.2023	11:43	27.02.2023	11:43	27.02.2023	11:43	27.02.2023	11:48	27.02.2023	11:48	27.02.2023	11:48	27.02.2023	11:48
2	1.22kW	27.02.2023	11:38	27.02.2023	11:43	27.02.2023	11:43	27.02.2023	11:43	27.02.2023	11:48	27.02.2023	11:48	27.02.2023	11:48	27.02.2023	11:48
3	1.22kW	27.02.2023	11:38	27.02.2023	11:43	27.02.2023	11:43	27.02.2023	11:43	▲	▶						
Σ	3.66kW	27.02.2023	11:38	▲	▶												

Display, Drag indicator P+ #1-#3 of the basic device 1-4

Drag indicator delivered active power "P-"

Drag pointer P- #1		Basic device 1-4		Date & Time		Drag pointer P- #2		Basic device 1-4		Date & Time		Drag pointer P- #3		Basic device 1-4		Date & Time	
	Value		Date & Time														
1	0.33kW	27.02.2023	11:38	27.02.2023	11:43	27.02.2023	11:43	27.02.2023	11:43	27.02.2023	11:48	27.02.2023	11:48	27.02.2023	11:48	27.02.2023	11:48
2	0.33kW	27.02.2023	11:38	27.02.2023	11:43	27.02.2023	11:43	27.02.2023	11:43	27.02.2023	11:48	27.02.2023	11:48	27.02.2023	11:48	27.02.2023	11:48
3	0.33kW	27.02.2023	11:38	27.02.2023	11:43	27.02.2023	11:43	27.02.2023	11:43	▲	▶						
Σ	0.99kW	27.02.2023	11:38	▲	▶												

Display, Drag indicator P- #1-#3 of the basic device 1-4

Drag indicator apparent power "S"

Drag pointer S #1		Basic device 1-4		Date & Time		Drag pointer S #2		Basic device 1-4		Date & Time		Drag pointer S #3		Basic device 1-4		Date & Time	
	Value		Date & Time														
1	1.33kVA	27.02.2023	11:38	27.02.2023	11:43	27.02.2023	11:43	27.02.2023	11:43	27.02.2023	11:48	27.02.2023	11:48	27.02.2023	11:48	27.02.2023	11:48
2	1.34kVA	27.02.2023	11:38	27.02.2023	11:43	27.02.2023	11:43	27.02.2023	11:43	27.02.2023	11:48	27.02.2023	11:48	27.02.2023	11:48	27.02.2023	11:48
3	1.33kVA	27.02.2023	11:38	27.02.2023	11:43	27.02.2023	11:43	27.02.2023	11:43	▲	▶						
Σ	4.00kVA	27.02.2023	11:38	▲	▶												

Display, Drag indicator S #1-#3 of the basic device 1-4

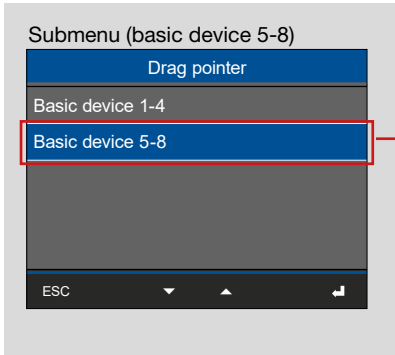

Drag indicator current "I"

Drag pointer I #3		Basic device 5-8	
Drag pointer I #2		Basic device 5-8	
Date & Time		27.02.2023 11:48	
Drag pointer I #1	Basic device 5-8	Date & Time	27.02.2023 11:48
Value		Date & Time	
27.02.2023 11:43		27.02.2023 11:48	
5	2.200A	27.02.2023 11:38	27.02.2023 11:43
6	1.100A	27.02.2023 11:38	27.02.2023 11:43
7	3.100A	27.02.2023 11:38	27.02.2023 11:43
Σ	6.400A	27.02.2023 11:38	↑
ESC			

Display, Drag indicator I #1-#3 of the basic device 5-8

Drag indicator for consumed active power "P+"

Drag pointer P+ #3		Basic device 5-8	
Drag pointer P+ #2		Basic device 5-8	
Date & Time		27.02.2023 11:48	
Drag pointer P+ #1	Basic device 5-8	Date & Time	27.02.2023 11:48
Value		Date & Time	
27.02.2023 11:43		27.02.2023 11:48	
5	1.22kW	27.02.2023 11:38	27.02.2023 11:43
6	1.22kW	27.02.2023 11:38	27.02.2023 11:43
7	1.22kW	27.02.2023 11:38	27.02.2023 11:43
Σ	3.66kW	27.02.2023 11:38	↑
ESC			

Display, Drag indicator P+ #1-#3 of the basic device 5-8

Drag indicator delivered active power "P-"

Drag pointer P- #3		Basic device 5-8	
Drag pointer P- #2		Basic device 5-8	
Date & Time		27.02.2023 11:48	
Drag pointer P- #1	Basic device 5-8	Date & Time	27.02.2023 11:48
Value		Date & Time	
27.02.2023 11:43		27.02.2023 11:48	
5	0.33kW	27.02.2023 11:38	27.02.2023 11:43
6	0.33kW	27.02.2023 11:38	27.02.2023 11:43
7	0.33kW	27.02.2023 11:38	27.02.2023 11:43
Σ	0.99kW	27.02.2023 11:38	↑
ESC			

Display, Drag indicator P- #1-#3 of the basic device 5-8

Drag indicator apparent power "S"

Drag pointer S #3		Basic device 5-8	
Drag pointer S #2		Basic device 5-8	
Date & Time		27.02.2023 11:48	
Drag pointer S #1	Basic device 5-8	Date & Time	27.02.2023 11:48
Value		Date & Time	
27.02.2023 11:43		27.02.2023 11:48	
5	1.33kVA	27.02.2023 11:38	27.02.2023 11:43
6	1.34kVA	27.02.2023 11:38	27.02.2023 11:43
7	1.33kVA	27.02.2023 11:38	27.02.2023 11:43
Σ	4.00kVA	27.02.2023 11:38	↑
ESC			

Display, Drag indicator S #1-#3 of the basic device 5-8

Menu (Multifunction channels)

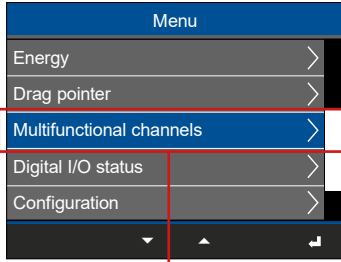

Submenu (current measurement)

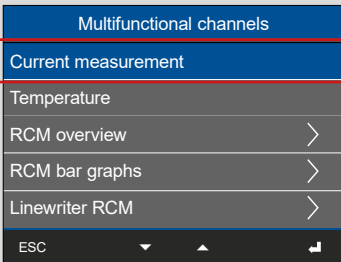

Current measurement		
	Value	Max.
Ch1	0.56mA	0.65mA
Ch2	0.55mA	0.63mA
Ch3	0.57mA	0.66mA
Ch4	0.59mA	0.68mA
ESC		

Display "Current measurement" for multifunction channels 1-4 with current and maximum value

Submenu (temperature)

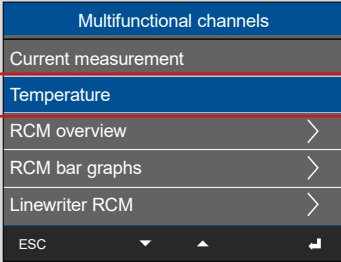

Temperature		
	Value	Max.
Ch1	24.3°C	253.4°C
Ch2	--	--
Ch3	--	--
Ch4	--	--
ESC		

Display "Temperature" of multifunction channel 1 with temperature and maximum value (channels 2-4 without measurement).

Submenu (RCM overview)

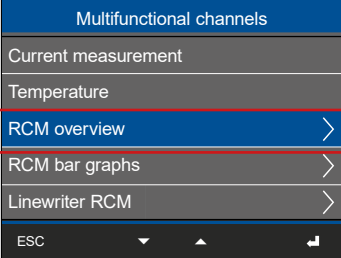

RCM overview	
RCM 1 & 2	
RCM 3 & 4	
ESC	

RCM 1 & 2		
	RCM 1	RCM 2
Current	5090mA	5100mA
Current (max)	5090mA	5100mA
Threshold	2000mA	2000mA
Reference	--	--
ESC		

Display "RCM 1 & 2".

RCM overview	
RCM 1 & 2	
RCM 3 & 4	
ESC	

RCM 3 & 4		
	RCM 3	RCM 4
Current	--	--
Current (max)	--	--
Threshold	--	--
Reference	--	--
ESC		

Display "RCM 3 & 4".

Submenu (RCM bar charts)

- Multifunctional channels
- Current measurement
- Temperature
- RCM overview >
- RCM bar graphs >**
- Linewriter RCM >
- ESC

RCM bar graphs

RCM bar graphs 1 & 2

RCM bar graphs 3 & 4

ESC

RCM bar graphs 1 & 2

RCM 1

[mA] 0 1000 2000 3000 4000 5000

RCM 2

[mA] 0 1000 2000 3000 4000 5000

ESC

Display "Bar chart 1 & 2".

RCM bar graphs 3 & 4

RCM 3

[mA] 0 1000 2000 3000 4000 5000

RCM 4

[mA] 0 1000 2000 3000 4000 5000

ESC

Display "Bar chart 3 & 4".

Submenu (res. current history)

- Multifunctional channels
- Current measurement
- Temperature
- RCM overview >
- RCM bar graphs >
- Linewriter RCM >**
- ESC

Linewriter RCM

Linewriter RCM 1

Linewriter RCM 2

Linewriter RCM 3

Linewriter RCM 4

ESC

Linewriter RCM 1

6.250A

5.000A

3.750A

2.500A

1.250A

0.000A

ESC

Display "Res. current history 1", I-RCM and limit value 1.

Menu (digital I/O status)

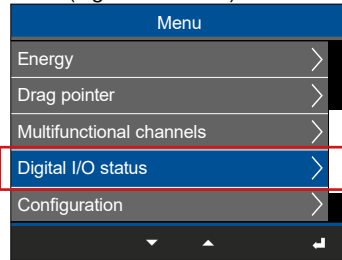

Digital I/O status

- Basic device >
- Digital I/O status, modules >

ESC

Digital I/O status, basic device

DI1	DI2	DI3	DI4
0	0	0	0
0	0	0	0
DO1	DO2	DO3	DO4

ESC

Display of status messages of the basic device digital inputs and outputs.

i INFORMATION

The submenu *Digital I/O status of modules* only appears for measurement devices with further modules of type 800-DI14 connected!

Please note the usage information for the modules or project-specific applications with integrated modules!

Menu (Configuration)

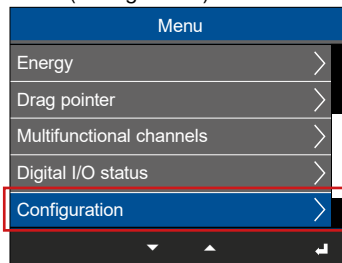

i INFORMATION

- For descriptions of the configuration displays of the device, refer to section „11. Configuration“ on page 66.
- Descriptions of module-specific measurement-device and menu displays can be found in the usage information for the modules.

Menu (Diagnostics)

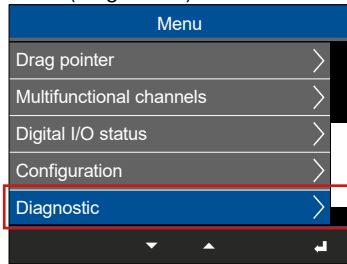

i INFORMATION

Detailed information about the modules, the menu item *Diagnostics* and the module identification can be found in the user manual of the modules. Please refer to the usage information for project-specific applications with integrated modules if applicable.

Menu (System information)

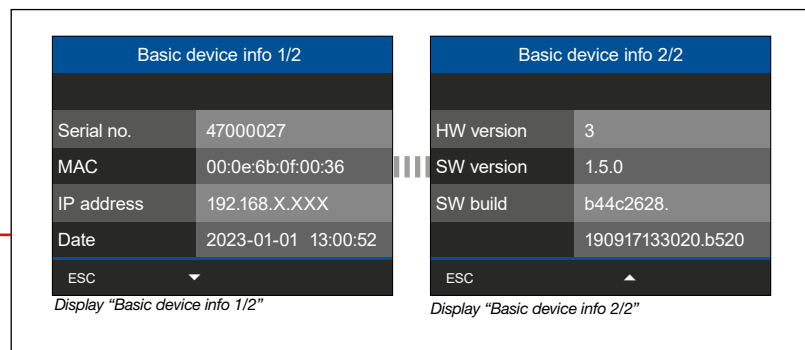
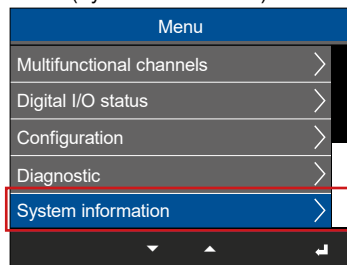

16. Connection example

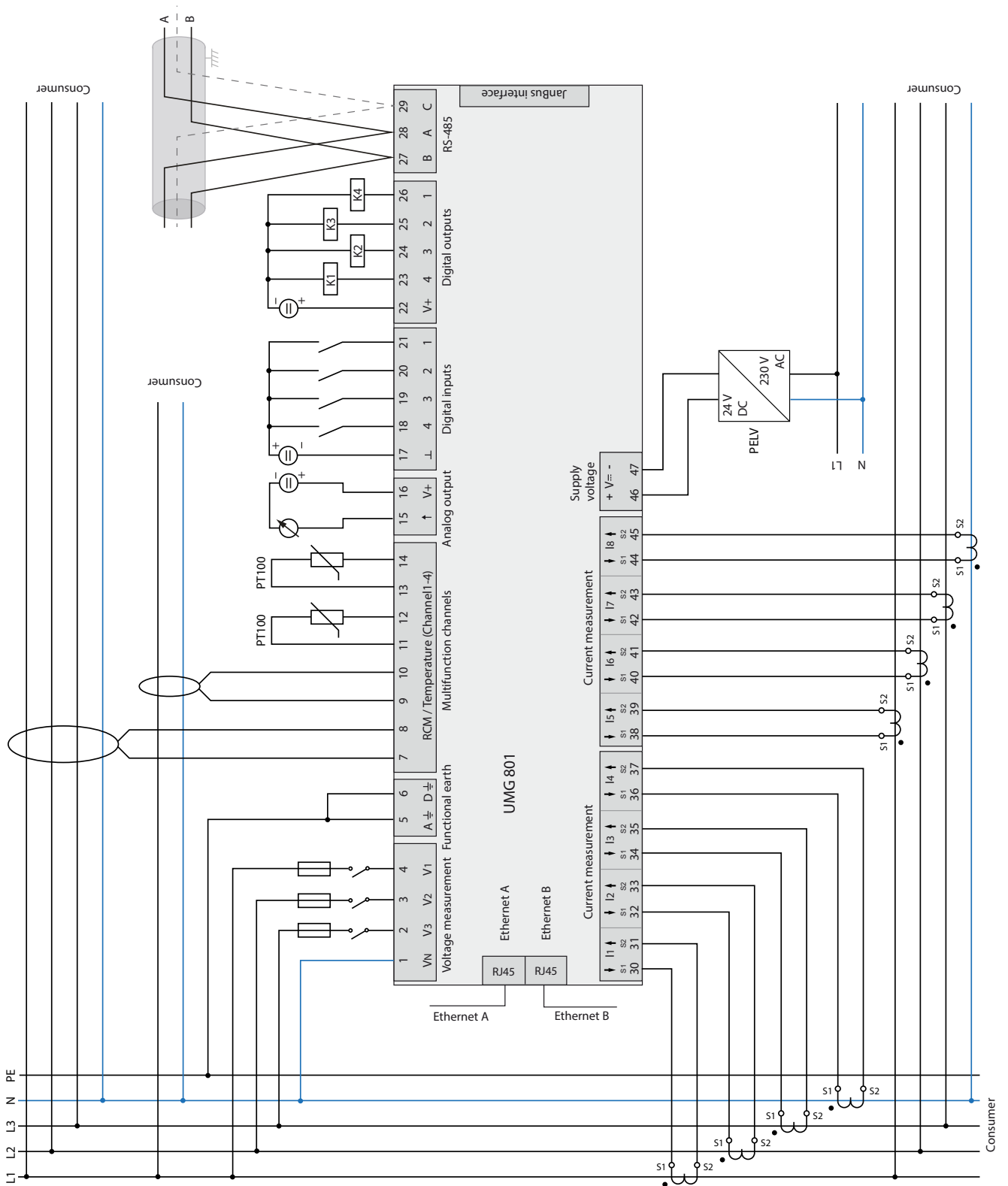

17. Dismounting

Dismounting the measurement device:

- ①. **Disconnect the system/measurement device from the power supply before starting work! Secure it against being switched on! Check to be sure it is de-energized! Ground and short circuit! Cover or block off adjacent live parts!**
- ②. Disconnect the wiring and connection terminals of the measurement device and, as needed, of connected modules.

- ③. Remove the end brackets and, if applicable, also the end brackets of connected module series.
- ④. Unlock all bottom bolts of the measurement device. If necessary, use a screwdriver. For measurement devices and module series, disconnect the modules from the UMG 801 measurement device beforehand!
- ⑤. Pull the measurement device vertically out of the bus connector.
- ⑥. Disconnect the bus connector by opening the retaining brackets (screwdriver).

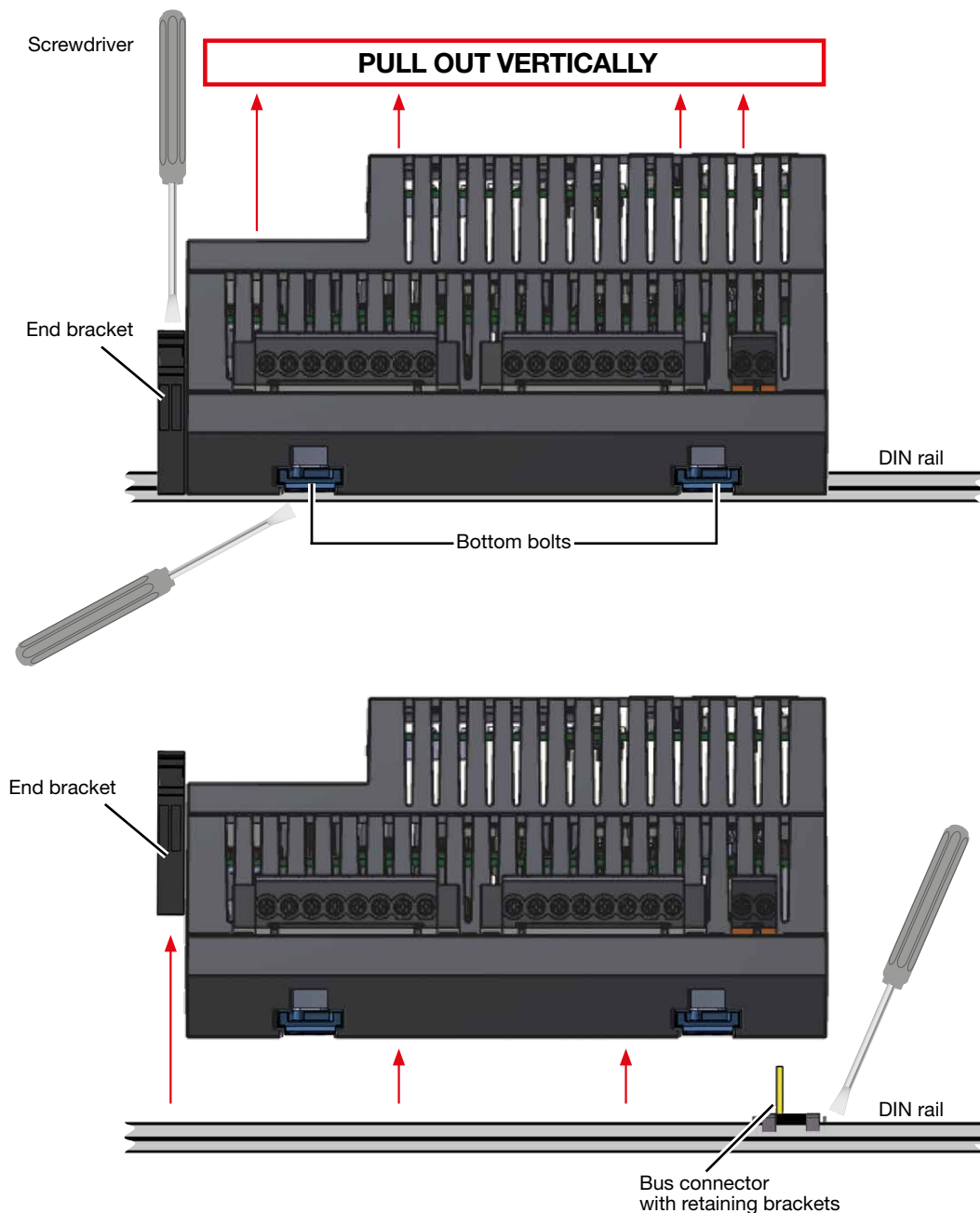

Fig. Dismounting the measurement device

18. Device homepage

The UMG 801 has an integrated web server, which displays a wide variety of data in a clear form on a device homepage. You can access the device homepage with a web browser.

This means that without separate software, a PC with an installed web browser can be used to:

- Retrieve current measured values.
- Configure basic settings on the measurement device.
- Retrieve the power quality status of your meter or application in a simple and understandable presentation (as PQDIF/COMTRADE file downloads or in an events and transients overview).

- Create an "IP address whitelist" of legitimate, verified devices that have access to the Modbus via the Ethernet interfaces of the UMG 801.

The device homepage uses the standardized transmission protocol HTTP.

You can access the device homepage by entering the measurement device IP address in the web browser of your end device (see Sect. "8.1 Functions of the Ethernet interfaces" on p. 52 and as of Sect. "11.2 Configuring Ethernet (TCP/IP)" on p. 66).

18.1 "Home" start page

UMG801 - NAME (Channel 1 - 4)						
Channel	Current	Power	Energy	Cos Phi	Power Factor	THD-I
1	0.00 A	0.00 W	-0.00 Wh	NaN	NaN	NaN
2	0.00 A	0.00 W	-0.00 Wh	NaN	NaN	NaN
3	0.00 A	0.00 W	-0.00 Wh	NaN	NaN	NaN
4	0.00 A	not applicable	not applicable	not applicable	not applicable	NaN
Total 1 - 3	0.00 A	0.00 W	0.00 Wh	NaN	NaN	not applicable
Total 1 - 4	0.00 A	not applicable	not applicable	not applicable	not applicable	not applicable

"Home" start page of the UMG 801 device homepage.

18.1.1 Login

To configure the measurement device or modules via the device homepage, you need the login data, consisting of an unchangeable **user name** and the corresponding **password**.

Default settings:

- User name (unchangeable): **admin**
- Password: **Janitza**

i INFORMATION

**Protect yourself from data misuse by changing your password after entering it for the first time!
Document the password securely!**

The screenshot shows the Janitza UMG801 device homepage. A login dialog box is open, prompting for a username and password. The username is pre-filled with 'admin'. The password field is empty. Below the dialog box, there is a table showing measurement data for channels 1-4.

UMG801 - NAME (Channel 1 - 4)						
Channel	Current	Power	Energy	Cos Phi	Power Factor	THD-I
1	0.00 A	0.00 W	-0.00 Wh	NaN	NaN	NaN
2	0.00 A	0.00 W	-0.00 Wh	NaN	NaN	NaN
3	0.00 A	0.00 W	-0.00 Wh	NaN	NaN	NaN
4	0.00 A	not applicable	not applicable	not applicable	not applicable	NaN
Total 1 - 3	0.00 A	0.00 W	0.00 Wh	NaN	NaN	not applicable
Total 1 - 4	0.00 A	not applicable	not applicable	not applicable	not applicable	not applicable

"Login" dialog box of the UMG 801 device homepage.

18.1.2 Change password

After the first login, change the password in the "**Change password**" dialog box under the menu bar item "**Settings**".

The screenshot displays the Janitza UMG801 web interface. The top navigation bar includes a home icon, 'Measurement Values', 'Settings' (highlighted with a red box), and 'Information'. The 'Settings' menu is expanded, and the 'Change password' option is selected, opening a dialog box. The dialog box contains a warning: 'Warning! This will affect all admin related logins!'. Below the warning are three input fields: 'Old password' (with placeholder text 'Old password'), 'New password' (with placeholder text 'New password'), and 'Confirm password' (with placeholder text 'Confirm new password'). A blue 'Save settings' button is located at the bottom of the dialog box. The background shows a list of settings categories: NTP server, Network, Whitelist (Modbus port 502), Events and transients, Current transformer and nominal values, Firmware update, and Reset options.

"Change password" dialog box under "Settings" menu bar item.

18.2 "Measured values" menu bar item

18.2.1 Details

The screenshot shows the Janitza UMG 801 web interface. At the top, there is a navigation bar with 'Measurement Values', 'Settings', and 'Information'. The 'Details' menu item is highlighted with a red box and a circled '6'. Below the navigation bar, the 'Details' page is displayed, showing a central image of the UMG 801 device and a list of measurement categories on the left. The categories are: Current (5), Voltage (4), Power (3), Harmonics (2), and Energy (1). Each category has a dropdown arrow.

Item	Control element	Description
1	Energy selection field	Display of energy values (active, reactive and apparent energy) per channel as well as total values
2	Harmonics selection field	Display of values per channel and total values - Total Harmonic Distortion - Current (THD-I), Total Harmonic Distortion - Voltage (THD-U), Total Demand Distortion (TDD) and average values (average THD-I, TDD)
3	Power selection field	Display of values per channel and total values (active, reactive, apparent power, distortion power, CosPhi, power factor)
4	Voltage selection field	Display of values per channel and total values - rms voltage, 3-phase values, frequency and average values of voltage LL and LN.
5	Current selection field	Display of values per channel and total values - rms current and average values of the current.
6	Login (blue) / Logout (red) buttons	<ul style="list-style-type: none"> · Login (blue) - opens the "Login" dialog box with an unchangeable <i>User name (admin)</i> and a place for the input of the <i>password</i> to the device homepage configuration. Default settings: User name (unchangeable): admin - password: Janitza. After the first login, change the password under "Settings" (see Sect. "18.1.1 Login" on p. 121 and Sect. "18.1.2 Change password" on p. 122). · Logout (red) - closes the device homepage configuration.

Tab. UMG 801 homepage: Measured values > Details

18.2.2 Events and transients

Item	Control element	Description
1	Events and transients list element	List display of Events and transients with time stamp and error message (as download in PQDIF format / COMTRADE in DAT and CFG format), depending on the time period set (Item 4).
2	Transients slide button	Display of Transients with time stamp and error message (as download in PQDIF and COMTRADE format), depending on the time period set (Item 4).
3	Events slide button	Display of Events with time stamp and error message (as download in PQDIF and COMTRADE format), depending on the time period set (Item 4).
4	Period buttons	Display of events and transients sorted by the time periods: <ul style="list-style-type: none"> · The last 24 hours · The last 7 days · The last 30 days · All

Tab. UMG 801 homepage: Measured values > Events and transients

18.3 "Settings" menu bar item

The screenshot shows the Janitza UMG 801 web interface. The top navigation bar includes 'Measurement Values', 'Settings' (highlighted with a red box), and 'Information'. The 'Settings' menu is open, displaying a list of configuration options. On the left side of the image, a vertical list of numbered circles (1-8) has lines pointing to specific items in the settings list: 1 points to 'Reset options', 2 to 'Firmware update', 3 to 'Change password', 4 to 'Current transformer and nominal values', 5 to 'Events and transients', 6 to 'Whitelist (Modbus port 502)', 7 to 'Network', and 8 to 'NTP server'.

Item	Control element	Description
1	Reset fold-out dialog	Dialog box with the options to reset the Energy values and/or Statistics .
2	Firmware update fold-out dialog	Opens the Firmware update dialog box (cf. Sect. "19.6 Firmware update via the GridVis® software" on p. 131).
3	Change password fold-out dialog	Option for changing the password with the input fields: <ul style="list-style-type: none"> • Old password • New password • Confirm password
4	Fold-out dialog Current transformers and nominal values	Configuration of the Current transformers and nominal values for the voltage and current measurements.
5	Events and transients fold-out dialog	Configuration (read only - unchangeable) of Events and transients .
6	Whitelist (Modbus port 502) fold-out dialog	Opens the Whitelist (Modbus port 502) dialog box (cf. Sect. "18.3.2 Whitelist (Modbus port 502)" on p. 127).
7	Network fold-out dialog	Configuration of the measurement device Network (Ethernet communication). Configuration of the Ethernet interfaces "external (A)" and "internal (B)" - (Default settings for A = " dynamic " and B = " static " - see Sect. "11.2 Configuring Ethernet (TCP/IP)" on p. 66).
8	NTP server fold-out dialog	Configuration of up to 6 NTP servers (standard server for time synchronization)

Tab. UMG 801 homepage: Settings

18.3.1 Firmware update

Item	Control element	Description
1	<i>Firmware update</i> fold-out dialog	Selection field with upload button for a Firmware update of your measurement device. The most up-to-date firmware for the UMG 801 can be found on the Janitza homepage.

Tab. UMG 801 homepage: Settings > Firmware update

18.3.2 Whitelist (Modbus port 502)

The screenshot displays the Janitza UMG 801 web interface. At the top, the navigation bar includes 'Measurement Values', 'Settings' (highlighted with a red box), and 'Information'. The 'Settings' menu is expanded, showing 'Whitelist (Modbus port 502)' as the selected option, indicated by a circled '1'. Below the menu, the configuration area is divided into two columns: 'Interface A' and 'Interface B'. Each column contains ten input fields labeled 'IP Address 1' through 'IP Address 10'. A 'Save settings' button is located at the bottom of the configuration area. The page also shows a 'Date / Time' of 04.10.2022 12:17:14 and a 'Device name' of UMG801-4700-0093.

Item	Control element	Description
1	Whitelist (Modbus port 502) fold-out dialog	Configuration of a whitelist - a list of legitimate, verified devices that have access to the Modbus via the Ethernet interfaces of the UMG 801. If no device is entered in the <i>Whitelist</i> , the "Whitelisting" feature is deactivated.

Tab. UMG 801 homepage: Settings > Whitelist

18.4 "Information" menu bar item

18.4.1 Device information

The screenshot shows the Janitza web interface for the UMG 801 device. The top navigation bar includes 'Measurement Values', 'Settings', and 'Information'. The 'Information' menu is expanded, with 'Device information' highlighted in red. A circled '1' points to this menu item. Below the navigation, the 'Device information' page is displayed, showing a table with general information, voltage transformer ratios, and current transformer ratios.

General information	
Description	Actual value
Device name	UMG801-4700-0093
Device description	
Production number	2000503804
Hardware version	2
Serial number	47000093
Software version	1.3.1-dev+98d9c949.220430000641.b182.rwd.head

Voltage transformer ratios	
Description	Actual value
L1, L2, L3	400 V / 400 V

Current transformer ratios				
Group	L1	L2	L3	L4
Measurement Group 1	5 A / 5 A	5 A / 5 A	5 A / 5 A	5 A / 5 A
Channel 5 - 8	5 A / 5 A	5 A / 5 A	5 A / 5 A	5 A / 5 A
Multifunction Channel	2 A / 0 A	3 A / 0 A	4 A / 0 A	5 A / 1 A

Item	Control element	Description
1	Device information, UMG 801 fold-out dialog	Overview of the measurement device in your application with general information, information about voltage transformer ratios and current transformer ratios.

Tab. UMG 801 homepage: Information > Device information

18.4.2 Modbus address list

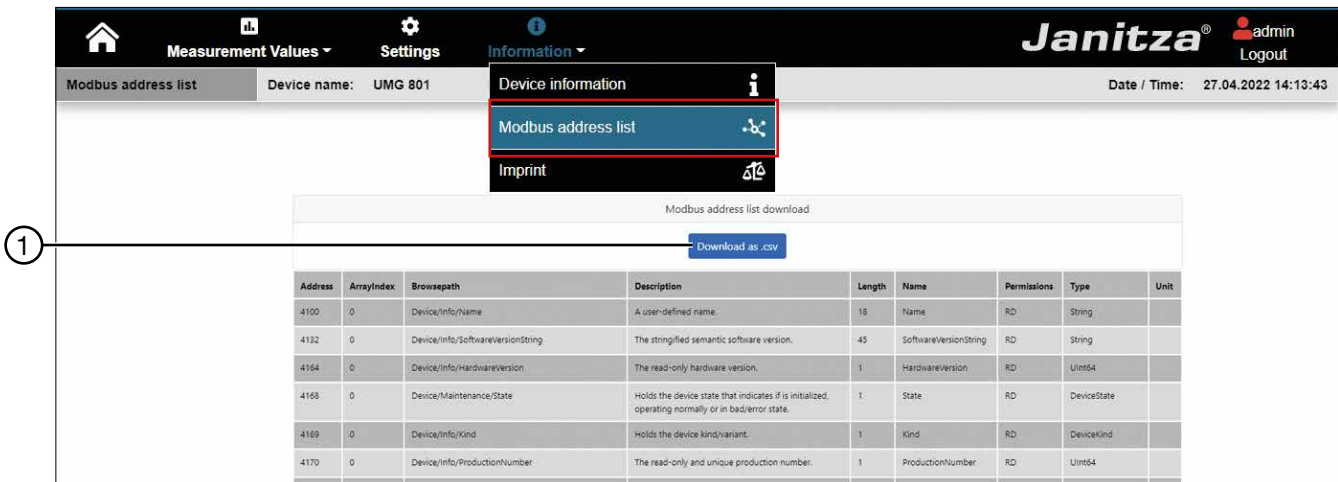

Item	Control element	Description
1	The <i>Download as csv file</i> button in the <i>Modbus address list</i> window	List of Modbus addresses (with the <i>Download as csv file</i> button).

Tab. UMG 801 homepage: Information > Modbus address list

18.4.3 Imprint

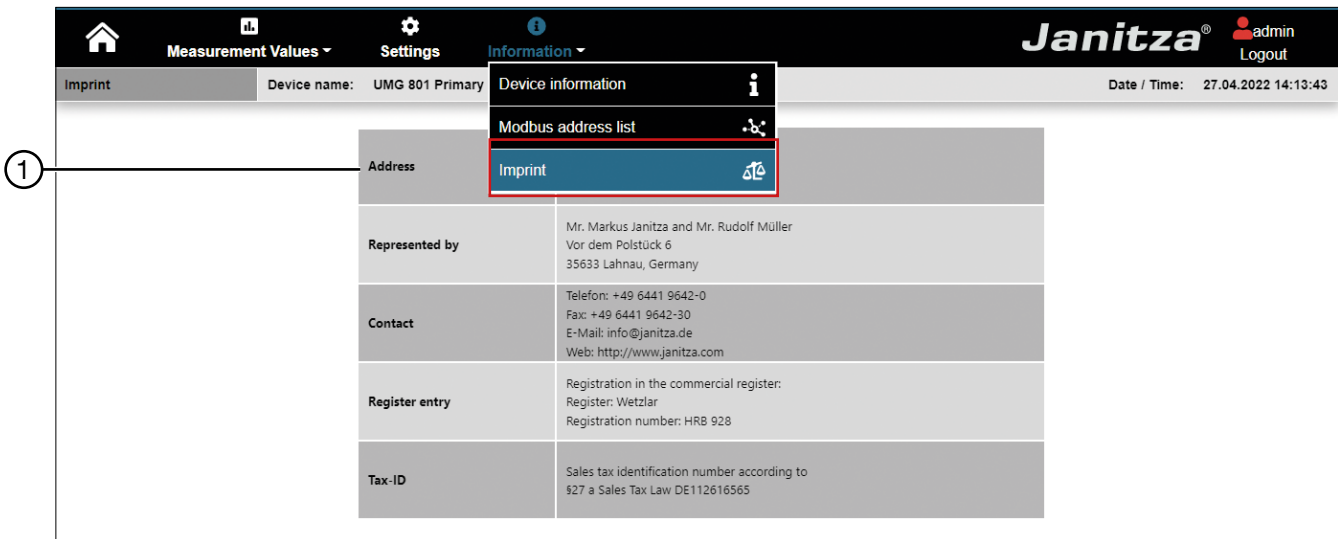

Item	Control element	Description
1	<i>Imprint</i> window	Manufacturer imprint

Tab. UMG 801 homepage: Information > Imprint

19. Service and maintenance

The manufacturer, Janitza electronics GmbH, subjects the device to various safety tests before delivery and marks it with a seal.

INFORMATION

- Opened devices (damaged or removed seal) require new safety checks for safe operation!
- The manufacturer warranties only unopened devices!

19.1 Repair and calibration

Repair and calibration of the device must only be carried out by the manufacturer or an accredited laboratory!

The manufacturer recommends calibrating the device every 5 years!

WARNING

Warning of unauthorized tampering or improper use of the device.

Opening, dismantling or unauthorized manipulation of the device which goes beyond the mechanical, electrical or other operating limits indicated can lead to material damage or injury, up to and including death.

- **Only electrically qualified personnel are permitted to work on the devices and their components, assemblies, systems and current circuits!**
- **Always use your device or component only in the manner described in the associated documentation.**
- **In the event of visible damage, or for the purpose of repair and calibration, return the device to the manufacturer!**

19.2 Front panel foil and display

Please note the following for the care and cleaning of the front foil and the display:

ATTENTION

Material damage due to improper care and cleaning of the device.

The use of water or other solvents, such as denatured alcohol, acids, acidic agents for the front foil or the display can damage or destroy the device during cleaning. Water can, for example, penetrate into the device housing and destroy the device.

- **Clean the device, the front foil or the display with a soft cloth.**
- **Use a cloth moistened with clear water for heavy soiling.**
- **Clean fingerprints on the front foil or the display, for example, with a special LCD cleaner and a lint-free cloth.**
- **Do not use acids or acidic agents to clean the devices.**

19.3 Service

For questions not answered or described in this manual, please contact the manufacturer. Please be certain to have the following information ready to answer any questions:

- Device designation (see rating plate).
- Serial number (see rating plate).
- Software release (see system display).
- Measured voltage and supply voltage.
- An exact error description.

19.4 Device adjustment

The manufacturer adjusts the devices before delivery. No readjustment is required when the environmental conditions are complied with.

19.5 Firmware update via the device homepage

For a firmware update via the device homepage, please refer to the descriptions in Sect. "18. Device homepage" on p. 120.

19.6 Firmware update via the GridVis® software

For a firmware update, connect your device to a computer and obtain access via the GridVis® software:

- Open the Firmware Update Assistant by clicking "Update device" in the "Extras" menu.
- Select your update file and perform the update.

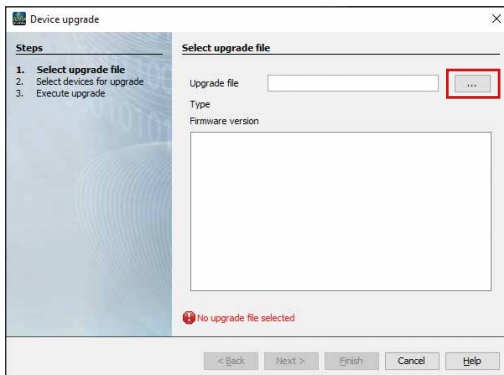

Fig. Updating the device firmware in the Grid Vis® software

19.7 Clock/Battery

The supply voltage supplies the internal clock of the measurement device. If the supply voltage fails, the battery takes over the supply of voltage to the clock. The clock provides date and time information, e.g. for recordings, minimum/maximum values and events.

The life expectancy of the battery is at least 5 years at a storage temperature of +45 °C (113 °F). The typical life expectancy of the battery is 8 to 10 years.

19.8 Battery replacement

Have a battery replacement carried out by a qualified electrician and observe the following warnings:

⚠ WARNING

Risk of injury due to electrical voltage! Serious personal injury or death may occur due to:

- Touching bare or stripped leads that are energized.
- Device inputs that pose a hazard when touched.

Also observe the following when handling your device and when changing the battery, before starting work:

- Disconnect the system/device from the power supply!
- Secure it against being switched on!
- Check to be sure it is de-energized!
- Ground and short circuit!
- Cover or block off adjacent live parts!

⚠ CAUTION

Risk of injury due to fire or burns!

The battery used in the device may cause fire or burns if used improperly.

- **Only replace the battery with the same type or types recommended by Janitza!**
- **Observe the polarity when installing the battery!**
- **Remove batteries only with non-conductive tools (e.g. plastic tweezers)!**
- **Do not recharge, disassemble, burn or heat batteries above 100 °C (212 °F)!**
- **Do not dispose of batteries with household waste! Follow the disposal instructions in the respective device documentation!**
- **Keep batteries away from children and animals!**
- **In case of damage, return devices with a soldered battery to the manufacturer, observing proper transport conditions!**

ⓘ INFORMATION

Grease or dirt on the contact surfaces forms a contact resistance which shortens the service life of the battery. Touch the battery only at the edges or with non-conductive tools.

20. Error messages

20.1 Overrange

The measuring range is exceeded if at least one of the voltage or current measurement inputs lies outside its measuring range.

ATTENTION

Material damage due to disregard of the connection instructions!

Voltages and currents outside the permissible measuring range can destroy the device.

- Adhere to the measuring range specifications from chap. „21. Technical specifications“ on page 134!
- **If the measuring range is exceeded, check your installation and connections!**

If the measuring range is exceeded, a warning appears in the device display, e.g. for the voltage, the warning "Range exceeded" with an indication of the voltage circuit.

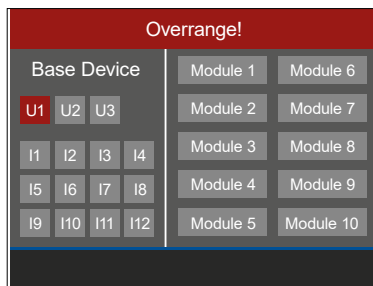

Fig. Example warning: Overvoltage U1

i INFORMATION

The device shows the overrange until it has been corrected! After elimination of the overrange, the corresponding measuring display appears.

Limit values for overrange conditions
(200 ms effective values):

$$I = 6 A_{\text{eff}}$$

$$U_{L-N} = 720 V_{\text{eff}}$$

20.2 Procedure in the event of a malfunction

Failure mode	Cause	Remedy
No display	External fuse for the supply voltage has tripped.	Replace fuse.
No current display.	No measured voltage connected.	Connect measured voltage.
	No measured current connected.	Connect measured current.
Displayed current is too great or too small.	Current measurement on the wrong phase.	Check connection and correct if necessary.
	Current transformer factor incorrectly programmed.	Read and program the current transformer ratio on the current transformer.
	Current harmonic exceeds current peak value at measurement input.	Install current transformer with larger current transformer ratio.
	The current at the measurement input is too low.	Install current transformer with smaller current transformer ratio.
Displayed voltage is too high or too low.	Measurement on the wrong phase.	Check connection and correct if necessary.
	Voltage transformer programmed incorrectly.	Read the voltage transformer ratio on the voltage transformer and program.
Displayed voltage is too high.	Overrange.	Use a voltage transformer.
	The voltage peak value at the measurement input was exceeded due to harmonics current.	Attention! Make sure that the measurement inputs are not overloaded.
Incorrect display "Inductive/capacitive phase shift"	Current path assigned to the wrong voltage circuit.	Check connection and correct if necessary.
Active power consumed/delivered is reversed.	At least one current transformer connection is reversed.	Check connection and correct if necessary.
	One current path assigned to the wrong voltage circuit.	Check connection and correct if necessary.
Active power too small or too great.	Incorrectly programmed current transformer ratio.	Read and program the current transformer ratio on the current transformer.
	Current path assigned to the wrong voltage circuit.	Check connection and correct if necessary.
	Incorrectly programmed voltage transformer ratio.	Read the voltage transformer ratio on the voltage transformer and program.
An input/output is not responding.	Incorrectly programmed input/output.	Check programming and correct if necessary.
	Incorrectly connected input/output.	Check connection and correct if necessary.
"Overrange" display	The measuring range has been exceeded.	Check connection and correct if necessary. Correct current/voltage transformer ratio.
No connection to the device	OPC UA: - Incorrect IP address/port	- Correct the IP address/port.
	RS-485: - Incorrect device address - Different bus speeds (baud rate) and/or data frames. - Incorrect protocol. - No termination.	- Correct the device address. - Correct the speed (baud rate). Correct the data frame. - Correct the protocol. - Terminate bus with termination resistor.
Despite the above measures, the device does not function.	Device defective.	Send the device and error description to the manufacturer for inspection.

ATTENTION

Material damage due to overloaded measurement inputs!

Too high current and voltage values overload the measurement inputs and can damage the device.

- Adhere to the limit values specified on the rating plate and in the technical data starting on Page 134!
- Check your installation and connections!

21. Technical specifications

21.1 Technical data

General	
Net weight	420 g (0.93 lb)
Device dimensions	Approx. B = 144 mm (5.67 in), H = 90 mm (3.54 in), D = 76 mm (2.99 in)
Width of the device in horizontal pitches	8 HP (1 HP = 18 mm)
Battery	Type: Lithium CR2032, 3 V (UL1642 approval)
Integrated memory	4 GB
Backlight service life	40000 h (50% of the start brightness)
Mounting orientation	As desired
Fastening/mounting - Suitable DIN rails - 35 mm (1.38 in)	<ul style="list-style-type: none"> · TS 35/7.5 according to EN 60715 · TS 35/10 · TS 35/15 x 1.5
Impact resistance	IK07 according to IEC 62262

Transport and storage	
The following specifications apply for devices transported and stored in the original packaging.	
Free fall	1 m (39.37 in)
Temperature	-25° C (-13 °F) to +70° C (158 °F)
Relative humidity	5 to 95% RH at 25 °C (77 °F), no condensation

Environmental conditions during operation	
The device <ul style="list-style-type: none"> • Is for weather-protected and stationary use. • Fulfills operating conditions according to DIN IEC 60721-3-3. • Has protection class II according to IEC 60536 (VDE 0106, part 1), a ground wire connection is not required! 	
Rated temperature range	-10 °C (14 °F) to +55 °C (131 °F)
Relative humidity	5 to 95% at 25 °C (77 °F), no condensation
Operating elevation/overvoltage category	2000 m (6562 ft) above sea level
	4000 m (6562 ft) above sea level
Pollution degree	2
Ventilation	No forced ventilation required.
Protection against foreign matter and water	IP20 according to EN60529

Supply voltage	
Nominal range	DC: 24 V, PELV
Operating range	+/-10% of nominal range
Power consumption	max. 4 W
Maximum power consumption with modules	14 W (UMG 801: 4 W plus modules: max. 10 W)
Recommended overcurrent protective device for line protection	2-6 A, (Char. B), IEC/UL approval

Voltage measurement	
Three-phase 4-conductor systems with rated voltages up to	480 V _{LN} / 830 V _{LL} (+/-10%) according to IEC 347 V _{LN} / 600 V _{LL} (+/-10%) according to UL
3-phase 3-conductor systems (grounded) with rated voltages up to	830 V _{L-L} (+/-10%) according to IEC 600 V _{L-L} (+/-10%) according to UL
3-phase 3-conductor systems (non-grounded) with rated voltages up to	690 V _{L-L} (+/-10%) according to IEC 600 V _{L-L} (+/-10%) according to UL
Overvoltage category up to 2000 m	· 1000 V CAT III according to IEC · 600 V CAT III according to UL · 600 V CAT IV according to IEC
Overvoltage category up to 4000 m	· 600 V CAT III according to IEC
Rated surge voltage	8 kV
Protection of the voltage measurement	1 - 10 A tripping characteristic B (with IEC/UL approval)
Measuring range L-N	0 ¹⁾ .. 720 V _{eff} (max. overvoltage 1000 V _{eff})
Measuring range L-L	0 ¹⁾ .. 1000 V _{eff} (max. overvoltage 1000 V _{eff})
Measuring range N-PE	up to 100 V
Resolution	16 bit
Crest factor	1.6 (referred to measuring range 600 V L-N)
Impedance	4 MΩ/phase
Power consumption	approx. 0.1 VA
Sampling frequency	51.2 kHz
Frequency of fundamental oscillation - Resolution	40 Hz .. 70 Hz 0.01 Hz
Harmonics	1 .. 127.

1) ... The device only measures if at least one voltage measurement input has an L-N voltage of > 10 V_{eff} or an L-L voltage of > 18 V_{eff} present.

Current measurement (../1 A) (../5 A)	
Nominal current	5 A
Channels	8 · 2 systems - L1, L2, L3, N (optional) · Single channels
Measuring range	0.005 .. 6 A _{eff}
Crest factor (relative to nominal current)	1.98
Overload for 1 s	120 A (sinusoidal)
Resolution	0.1 mA (color graphic display 0.01 A)
Overvoltage category	300 V CATII
Rated surge voltage	2.5 kV
Power consumption	approx. 0.2 VA (R _i = 5 mΩ)
Sampling frequency	25.6 kHz
Harmonics	1 .. 63rd

The device has, optionally, 4 multifunction channels, for use as

- Residual current measurement inputs and/or temperature measurement inputs (mixed),
- Additional system inputs (L1, L2, L3; N)

Residual current measurement (RCM)	
Nominal current	30 mA _{eff}
Measuring range	0 .. 40 mA _{eff}
Operating current	50 µA
Resolution	1 µA (color graphic display 0.01 A)
Crest factor	1.414 (relative to 40 mA)
Load	4 Ω
Overload for 20 ms	50 A
Overload for 1 s	5 A
Permanent overload	1 A
Norm	IEC/TR 60755 (2008-01), Type A, Type B and B+ (via corresponding current transformers)

Temperature measurement				
Update time	1 s			
Total load (sensor and cable)	max. 4 kΩ			
Cable	Up to 30 m (32.81 yd) not shielded Greater than 30 m (32.81 yd) shielded			
Suitable temperature sensor types	KTY83, KTY84, PT100, PT1000			
Measuring accuracy	Temperature sensor type	Temp. range	Resistance range	Measurement uncertainty
	KTY83	-55 °C ... +175 °C (-67 °F ... +347 °F)	500 Ω ... 2.6 kΩ	±1.5% rng
	KTY84	-40 °C ... +300 °C (-40 °F ... +572 °F)	350 Ω ... 2.6 kΩ	±1.5% rng
	PT100	-99 °C ... +500 °C (-146 °F ... +932 °F)	60 Ω ... 180 Ω	±1.5% rng
	PT1000	-99 °C ... +500 °C (-146 °F ... +932 °F)	600 Ω ... 1.8 kΩ	±1.5% rng

Digital inputs	
4 digital inputs, solid state relays, not short-circuit proof.	
Maximum counter frequency	20 Hz
Input signal applied	18 .. 28 V DC (typically 4 mA)
Input signal not applied	0 .. 5 V DC, current less than 0.5 mA

Digital outputs	
4 digital outputs, solid state relays, not short-circuit proof.	
Switching voltage	Max. 60 V DC
Switching current	max. 50 mA _{eff} DC
Response time	approx. 500 ms
Digital output (energy pulses)	max. 20 Hz

Cable length (digital inputs/outputs)	
Up to 30 m (32.81 yd)	Unshielded
Greater than 30 m (32.81 yd)	Shielded

Analog outputs 1 channel	
External supply	max. 33 V DC
Current	0/4...20 mA DC
Update time	0.2 s
Load	max. 300 Ω
Resolution	10 bit

RS-485 interface 3-conductor connection with A, B, GND	
Protocol	Modbus RTU/Server (formerly slave) Modbus RTU/Gateway
Transmission rate	9.6 kbps, 19.2 kbps, 38.4 kbps, 57.6 kbps, 115.2 kbps
Termination	DIP switches

Ethernet interfaces	
Connection	2 x RJ45 (can be used separately)
Function	Modbus gateway
Time synchronization	NTP
Protocols, services	Ports
Modbus/TCP - Modbus/UDP	502 (UDP / TCP), modifiable
DNS (client)	53 (UDP)
DHCP (client)	67 / 68 (UDP)
HTTP	80 (TCP)
NTP	123 (UDP)
SFTP	22 (TCP)
OPC-UA (binary)	4840 (TCP)
Device identification (since version 1.3.0)	1111 (UDP)
Error message for events and transients according to	<ul style="list-style-type: none"> · PQDIF (IEEE 1159.3-2019) - file format: pqd. · COMTRADE (IEC 60255-24 Edition 2.0 2013-04 and IEEE Std C37.111-2013) - file format: dat, cfg.

Potential isolation and electrical safety of the interfaces

The interfaces (RS-485, Ethernet) have:

- Double insulation to the inputs of the voltage and current measurement.
- Functional insulation relative to each other, to the supply voltage, to the measurement inputs for residual current and temperature, to the digital inputs/outputs and to the analog output.

The interfaces of the connected devices require double or reinforced insulation against mains voltages (according to IEC 61010-1:2010).

Potential isolation and electrical safety of the multifunction channels (RCM, temp., mA current measurement)

The inputs of the multifunction channels have:

- Double insulation to the inputs of the voltage and current measurement.
- No insulation to each other or to the supply voltage.
- Functional isolation to the Ethernet, RS-485 interfaces, to the digital inputs/outputs and to the analog output.

External sensors and/or transformers require double insulation relative to system components with dangerous touch voltages (according to IEC61010-1:2010).

Potential isolation and electrical safety of the digital inputs and outputs (I/O) and the analog output

The digital inputs and outputs as well as the analog output are equipped with:

- Double insulation to the inputs of the voltage and current measurement.
- Functional isolation relative to each other, to the supply voltage, to the Ethernet, RS-485 and multifunction channel interfaces.

Connection capacity of the terminals - supply voltage

Connectible conductors. Only connect one conductor per terminal point!

Single core, multi-core, fine-stranded	0.2 - 2.5 mm ² , AWG 26-12
Wire ferrules (non-insulated) - Recommended strip length	0.2 - 2.5 mm ² , AWG 26-12 - 10 mm (0.39 in)
Wire ferrules (insulated) * - Recommended strip length **	0.2 - 2.5 mm ² , AWG 26-12 - 12 mm (≤ 1.5 mm ²), 10 mm (> 1.5 mm ²) / 0.47 in (≤ 1.5 mm ²), 0.39 in (> 1.5 mm ²)
Wire ferrules: Contact sleeve length **	8 - 12 mm (0.31 - 0.47 in)

* ... Applies to wire ferrules with a maximum plastic collar outer diameter of up to 4.5 mm (0.18 in).

**.. Depending on the type of wire ferrules used (wire ferrules manufacturer).

Connection capacity of the terminals - Current measurement

Connectible conductors. Only connect one conductor per terminal point!

Single core, multi-core, fine-stranded	0.2 - 2.5 mm ² , AWG 26-12
Wire ferrules (non-insulated) - Recommended strip length	0.2 - 2.5 mm ² , AWG 26-12 - 10 mm (0.39 in)
Wire ferrules (insulated) * - Recommended strip length **	0.2 - 2.5 mm ² , AWG 26-12 - 12 mm (≤ 1.5 mm ²), 10 mm (> 1.5 mm ²) / 0.47 in (≤ 1.5 mm ²), 0.39 in (> 1.5 mm ²)
Screw flange tightening torque	0.2 Nm (1.77 lbf in)
Wire ferrules: Contact sleeve length **	8 - 12 mm (0.31 - 0.47 in)

* ... Applies to wire ferrules with a maximum plastic collar outer diameter of up to 4.5 mm (0.18 in).

**.. Depending on the type of wire ferrules used (wire ferrules manufacturer).

Connection capacity of the terminals - voltage measurement

Connectible conductors. Only connect one conductor per terminal point!

Single core, multi-core, fine-stranded	0.08 - 4 mm ² , AWG 28-12
Wire ferrules (insulated/non-insulated)	0.25 - 2.5 mm ² , AWG 24-14
Strip length	8 - 9 mm (0.31 - 0.35 in)

Connection capacity of the terminals - functional earth A/D	
Connectible conductors. Only connect one conductor per terminal point!	
Single core, multi-core, fine-stranded	0.2 - 4 mm ² , AWG 24-12
Wire ferrules (non-insulated)	0.2 - 4 mm ² , AWG 24-12
Wire ferrules (insulated)	0.2 - 2.5 mm ² , AWG 26-14
Tightening torque	0.4 - 0.5 Nm (3.54 - 4.43 lbf in)
Strip length	7 mm (0.28 in)

Connection capacity of the terminals - Multifunction channels (RCM, Temp., mA current measurement)	
Connectible conductors. Only connect one conductor per terminal point!	
Single core, multi-core, fine-stranded	0.2 - 1.5 mm ² , AWG 24-16
Wire ferrules (non-insulated)	0.2 - 1.5 mm ² , AWG 26-16
Wire ferrules (insulated)	0.2 - 1 mm ² , AWG 26-18
Tightening torque	0.2 - 0.25 Nm (1.77 - 2.21 lbf in)
Strip length	7 mm (0.28 in)

Connection capacity of the terminals - Digital inputs/outputs, analog output	
Single core, multi-core, fine-stranded	0.2 - 1.5 mm ² , AWG 24-16
Wire ferrules (non-insulated)	0.2 - 1.5 mm ² , AWG 26-16
Wire ferrules (insulated)	0.2 - 1 mm ² , AWG 26-18
Tightening torque	0.2 - 0.25 Nm (1.77 - 2.21 lbf in)
Strip length	7 mm (0.28 in)

Connection capacity of the terminals - RS-485	
Single core, multi-core, fine-stranded	0.2 - 1.5 mm ² , AWG 24-16
Wire ferrules (non-insulated)	0.2 - 1.5 mm ² , AWG 26-16
Wire ferrules (insulated)	0.2 - 1 mm ² , AWG 26-18
Tightening torque	0.2 - 0.25 Nm (1.77 - 2.21 lbf in)
Strip length	7 mm (0.28 in)

Optional accessory pack (part. no., see Sect. "3.8 Accessories" on p. 21):

Connection capacity of the terminals - Functional earth A/D - Spring terminal (push-in terminal)	
Connectible conductors - only connect one conductor per terminal point!	
Single core, multi-core, fine-stranded (min. - max.)	0.5 mm ² - 2.5 mm ² , AWG 20-13
- Wire ferrules with collar * to DIN 46 228/4, (min. - max.)	0.5 mm ² - 2.5 mm ² , AWG 20-13
- Wire ferrules without collar to DIN 46 228/1, (min. - max.)	0.5 mm ² - 2.5 mm ² , AWG 20-13
Wire ferrules: - Contact sleeve length ** - Strip length	- 10 - 12 mm (0.39 - 0.47 in) - 10 - 12 mm (0.39 - 0.47 in)

* ... Applies to wire ferrules with a maximum plastic collar outer diameter of up to 3.5 mm (0.14 in).

**.. Depending on the type of wire ferrules used (wire ferrules manufacturer).

Connection capacity of the terminals - Multifunction channels (RCM, temp., mA current measurement) - Spring terminal (push-in terminal)	
Connectible conductors - only connect one conductor per terminal point!	
Single core, multi-core, fine-stranded (min. - max.)	0.14 mm ² - 1.5 mm ² , AWG 26-16
- Wire ferrules with collar * to DIN 46 228/4, (min. - max.)	0.25 mm ² - 1 mm ² , AWG 22-17
- Wire ferrules without collar to DIN 46 228/1, (min. - max.)	0.25 mm ² - 1.5 mm ² , AWG 22-16
Wire ferrules: - Contact sleeve length ** - Strip length	- 8 - 12 mm (0.31 - 0.47 in) - 10 - 12 mm (0.39 - 0.47 in)

* ... Applies to wire ferrules with a maximum plastic collar outer diameter of up to 3.5 mm (0.14 in).

**.. Depending on the type of wire ferrules used (wire ferrules manufacturer).

Connection capacity of the terminals - Digital inputs/outputs, analog output - Spring terminal (push-in terminal)	
Connectible conductors - only connect one conductor per terminal point!	
Single core, multi-core, fine-stranded (min. - max.)	0.14 mm ² - 1.5 mm ² , AWG 26-16
- Wire ferrules with collar * to DIN 46 228/4, (min. - max.)	0.25 mm ² - 1 mm ² , AWG 22-17
- Wire ferrules without collar to DIN 46 228/1, (min. - max.)	0.25 mm ² - 1.5 mm ² , AWG 22-16
Wire ferrules: - Contact sleeve length ** - Strip length	- 8 - 12 mm (0.31 - 0.47 in) - 10 - 12 mm (0.39 - 0.47 in)

* ... Applies to wire ferrules with a maximum plastic collar outer diameter of up to 3.5 mm (0.14 in).

**.. Depending on the type of wire ferrules used (wire ferrules manufacturer).

Connection capacity of the terminals - RS-485 - Spring terminal (push-in terminal)	
Connectible conductors - only connect one conductor per terminal point!	
Single core, multi-core, fine-stranded (min. - max.)	0.14 mm ² - 1.5 mm ² , AWG 26-16
- Wire ferrules with collar * to DIN 46 228/4, (min. - max.)	0.25 mm ² - 1 mm ² , AWG 22-17
- Wire ferrules without collar to DIN 46 228/1, (min. - max.)	0.25 mm ² - 1.5 mm ² , AWG 22-16
Wire ferrules: - Contact sleeve length ** - Strip length	- 8 - 12 mm (0.31 - 0.47 in) - 10 - 12 mm (0.39 - 0.47 in)

* ... Applies to wire ferrules with a maximum plastic collar outer diameter of up to 3.5 mm (0.18 in).

**.. Depending on the type of wire ferrules used (wire ferrules manufacturer).

21.2 Performance characteristics of functions

Function	Symbol	Accuracy class	Measuring range	Display range
Frequency	f	0.05 (IEC61557-12)	40 .. 70 Hz	40.00 .. 70.00 Hz
Voltage	U_{L-N}	0.2 (IEC61557-12)	10 .. 720 V _{eff}	0 .. 999 kV
Voltage	U_{L-L}	0.2 (IEC61557-12)	18 .. 1000 V _{eff}	0 .. 999 kV
Voltage harmonics currents	Uh	Cl. 1 (IEC61000-4-7)	1 .. 127	0 .. 999 kV
THD of the voltage	THDu	1.0 (IEC61557-12)	0 .. 999%	0 .. 999%

Function	Symbol	Accuracy class - 5 A nominal current	Measuring range	Display range
Total active power	P	0.2 (IEC61557-12)	0 .. 12.6 kW	0 .. 999 GW
Total reactive power	QA, Qv	1 (IEC61557-12)	0..16.6 kvar	0 .. 999 Gvar
Total apparent power	SA, Sv	0.5 (IEC61557-12)	0 .. 12.6 kVA	0 .. 999 GVA
Total active energy	Ea	0.2 (IEC61557-12) 0.2S (IEC62053-22) 0.5 (ANSI C12.20)	0 .. 999 GWh	0 .. 999 GWh
Total reactive energy	ErA, ErV	1 (IEC61557-12)	0 .. 999 Gvarh	0 .. 999 Gvarh
Total apparent energy	EapA, EapV	0.5 (IEC61557-12)	0 .. 999 GVAh	0 .. 999 GVAh
Phase current	I	0.2 (IEC61557-12)	0.005 .. 6 A _{eff}	0 .. 999 kA
Neutral conductor current calculated	INc	1.0 (IEC61557-12)	0.03 .. 25 A	0.03 .. 999 kA
Power factor	PFA, PFV	0.5 (IEC61557-12)	0.00 .. 1.00	0.00 .. 1.00
Current harmonics	Ih	Cl. 1 (IEC61000-4-7)	1 ... 63rd	0 .. 999 kA
THD of the current	THDi	1.0 (IEC61557-12)	0 .. 999%	0 .. 999%

Function	Symbol	Accuracy class - 1 A nominal current	Measuring range	Display range
Total active power	P	0.5 (IEC61557-12)	0 .. 12.6 kW	0 .. 999 GW
Total reactive power	QA, Qv	1 (IEC61557-12)	0 .. 16.6 kvar	0 .. 999 Gvar
Total apparent power	SA, Sv	0.5 (IEC61557-12)	0 .. 12.6 kVA	0 .. 999 GVA
Total active energy	Ea	0.5 (IEC61557-12) 0.5S (IEC62053-22)	0 .. 999 GWh	0 .. 999 GWh
Total reactive energy	ErA, ErV	1 (IEC61557-12)	0 .. 999 Gvarh	0 .. 999 Gvarh
Total apparent energy	EapA, EapV	0.5 (IEC61557-12)	0 .. 999 GVAh	0 .. 999 GVAh
Phase current	I	0.5 (IEC61557-12)	0.005 .. 6 A _{eff}	0 .. 999 kA
Neutral conductor current calculated	INc	1.0 (IEC61557-12)	0.03 .. 25 A	0.03 .. 999 kA
Power factor	PFA, PFV	1 (IEC61557-12)	0.00 .. 1.00	0.00 .. 1.00
Current harmonics	Ih	Cl. 1 (IEC61000-4-7)	1 ... 63rd	0 .. 999 kA
THD of the current	THDi	1.0 (IEC61557-12)	0 .. 999%	0 .. 999%

21.3 Parameter and Modbus address list

INFORMATION

A standard Modbus address list with explanations of measured values and a formulary can be found in the download area at www.janitza.com.

21.4 Information on saving measured values and configuration data

INFORMATION

The device stores the following measured values every 5 minutes at the latest:

- S0 meter readings
- Min. / max. / average values
- Energy values (work values)

The device saves configuration data immediately (1-2 s)!

22. Dimensional drawings

- The figures are for illustration purposes only and are not to scale.
- Please also note the dimensions of the terminals used during installation!
- All dimensions in mm (in).

i INFORMATION

In addition to the dimensional drawings in this user manual, also refer to the dimensional drawings in the usage information for the expansion modules, components, and especially the usage information for project-specific applications!

22.1 Basic device UMG 801

Front view

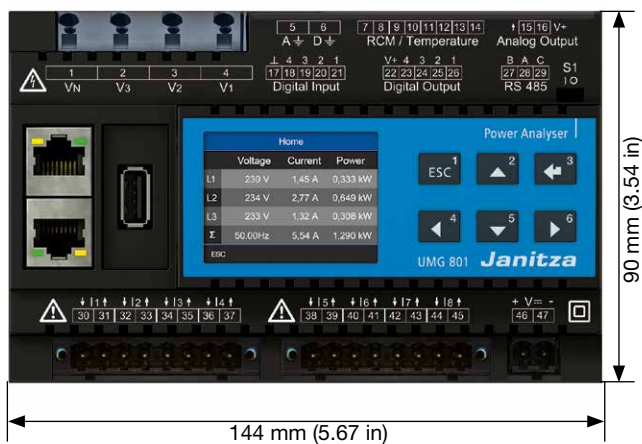

View from left

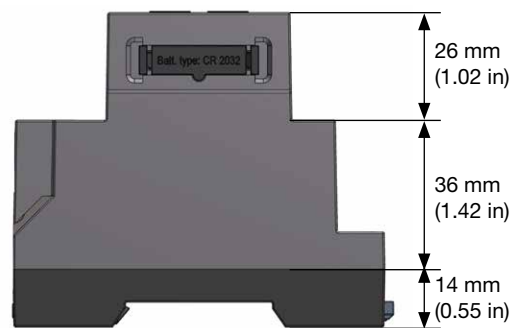

Bottom view

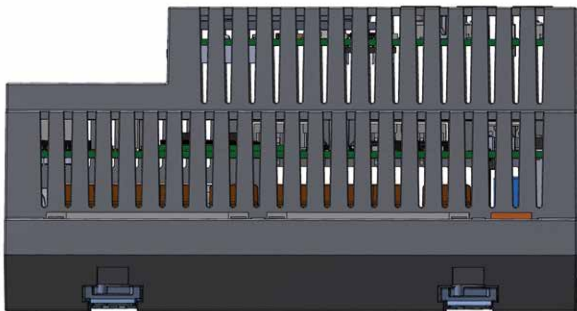

Top view

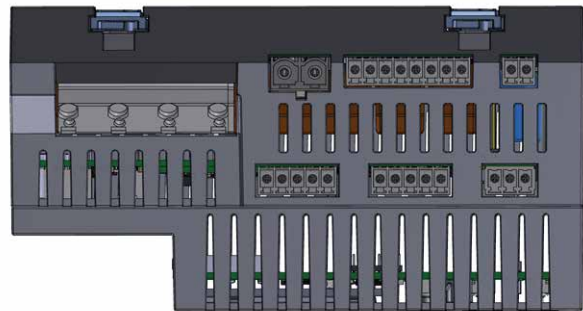

Rear view

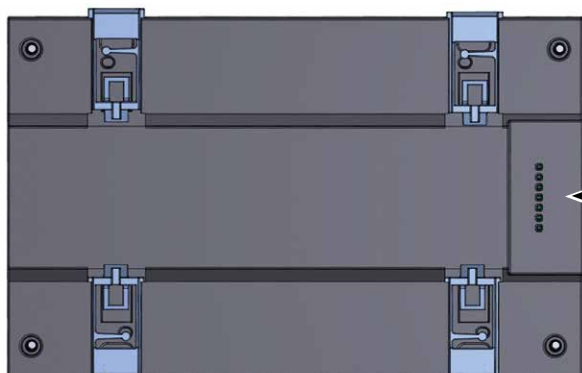

Connector for the bus connector.

22.2 Bus connector

Bus connector of the UMG 801 for mounting modules:

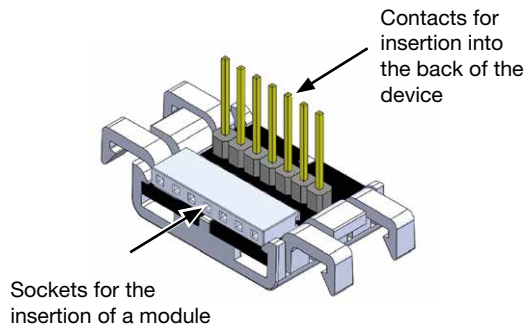

i INFORMATION

Observe Sect. "5. Mounting" on p. 30 when mounting the measurement device with bus connector.

Janitza[®]

Janitza electronics GmbH
Vor dem Polstück 6
D-35633 Lahnau

Support tel. +49 6441 9642-22
Email: info@janitza.com
info@janitza.com | www.janitza.com