

Field-wireable, M8, male, angled, 4 poles, soldering contact, 30V 4A

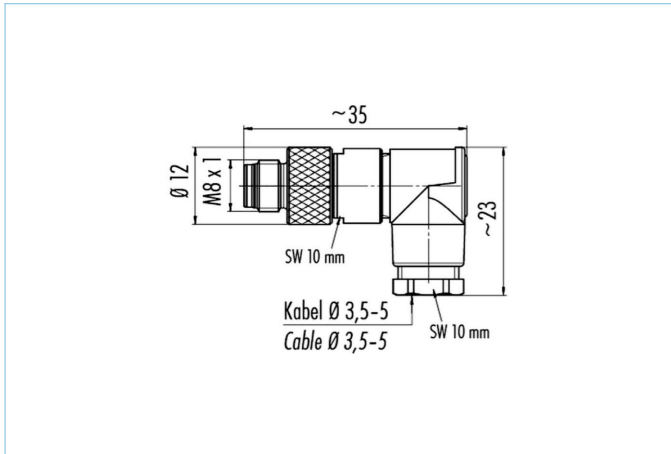

Product data	
Item description	SWSPC4L
Item-No.	8017366
Customs tariff-No.	85366990
Step-File	SWSPC4L.stp
EAN	4047106064778
Technical data	
Connector	male, angled, M8
Number of pins	4
Rated voltage	30V
Current load per pin (at 40°C)	4A
Insulation resistance	$\geq 10^9 \Omega$
Resistance	$\leq 3 m\Omega$
Ambient temperature product	-40°C...+85°C
Contact material	Metal, CuZn, gold-plated
Contact-carrier material	Plastic, PA, BK
Grip body material	Plastic, PBT/PA, BK
Coupling nut material	Metal, GD-ZN, nickel-plated
Connecting cross-section	max. 0.25 mm ²
Cable outlet	3,5...5 mm
Connecting type	Soldering contact
Standards	IEC 61076-2-104
Degree of protection (mounted)	IP67
Mechanical life-cycle	>100 mating cycles
Degree of pollution	3
Style	angled

Manual

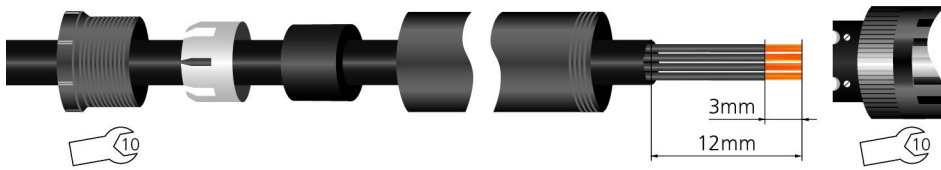

Classification

eCl@ss 6.0	27260702
eCl@ss 7.0	27440102
eCl@ss 8.0	27440102
eCl@ss 9.0	27440102
ETIM 5.0	EC002635
ETIM 6.0	EC002635

Link to product

<https://www.escha.net/en/products/standard/field-wireable-connectors/8017366>