

M12, female, straight, 4 poles, B-coded, M12, male, angled, 4 poles, B-coded, shielded, Profibus

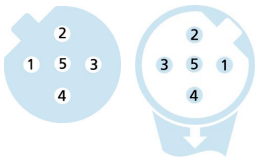
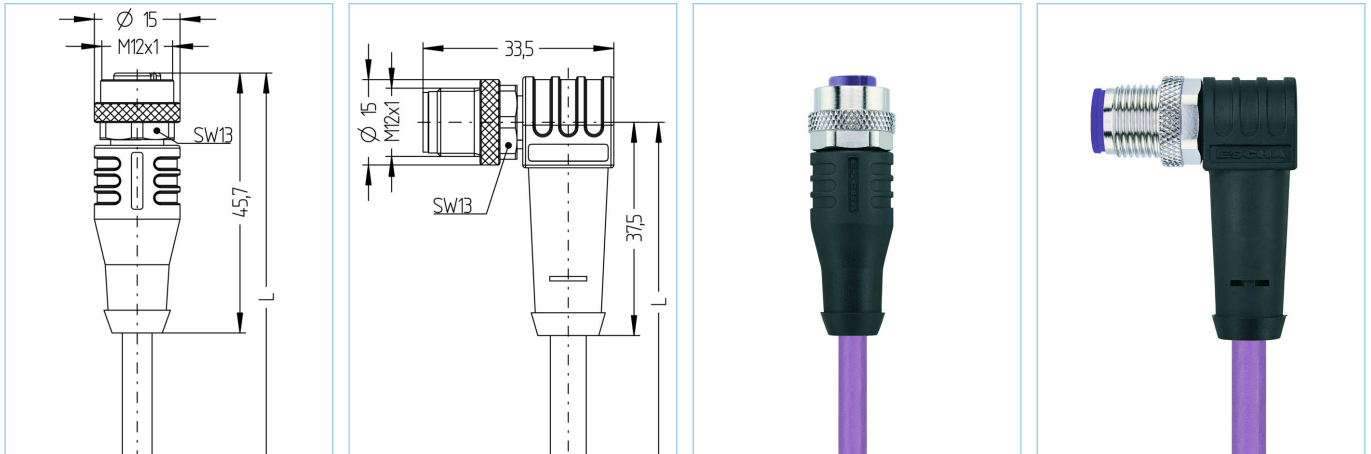

Product data		
Item description	PB-WAKSW2.012-5-PB-WWASSW2.012/S1800	
Item-No.	8043885	
Length	5m	
Customs tariff-No.	85444290	
Step-File	PB-WAKSW2-m-PB-WWASSW2.stp	
EAN	4047106003258	
Label-carrier	2 pieces	
Technical data	A-side	B-side
Connector	female, straight, M12	male, angled, M12
Number of pins	4	4
Pin assignment	1 n.c., 2 GN, 3 n.c., 4 RD	1 n.c., 2 GN, 3 n.c., 4 RD
Coding of	B	B
Rated voltage	60V	60V
Current load (at 40°C)	4A	4A
Insulation resistance	≥10 ⁹ Ω	≥10 ⁹ Ω
Resistance	≤ 5mΩ	≤ 5mΩ
Ambient temperature product	-30°C...+90°C	-30°C...+90°C
Contact material	Metal, CuZn, gold-plated	Metal, CuZn, gold-plated
Contact-carrier material	Plastic, TPU, VT	Plastic, TPU, VT
Grip body material	Plastic, TPU, BK	Plastic, TPU, BK
Coupling nut material	Metal, CuZn, nickel-plated	Metal, CuZn, nickel-plated
Sealing (female) material	FPM/FKM	
Shielding	with shielding	with shielding
Standards	IEC 61076-2-101	IEC 61076-2-101
Degree of protection (mounted)	IP65, IP67, IP68	IP65, IP67, IP68
Mechanical life-cycle	>100 mating cycles	>100 mating cycles
Degree of pollution	3	3

Cable	PUR, UL, S1800, Profibus
--------------	---------------------------------

UL- and CSA-listed shielded PUR-cable for automation technology (control of sensors and actuators). Suited for common variants of PROFIBUS DP and PROFIBUS PA. Setup and materials used allow for applications under harsh environment conditions (abrasion, bending, vibrations etc.). Drag-chain application is possible. (>1million bending cycles).

Outer diameter of jacket	7.60 mm
Cable-jacket material	PUR
Jacket color	VT similar RAL4001
Wire cross-section	1 x 2 x 0.34 mm ²
Wire insulation material	PE
Wire colors	RD, GN
Wire structure	19 x 0.15 mm
Bending radius (fixed)	5 x Ø-cable
Bending radius (repeated)	15 x Ø-cable
Temperature range (repeated)	-25°C...+80°C
Temperature range (fixed)	-50°C...+80°C
Temperature range (drag chain)	-25°C...+60°C
Drag chain-application	>1Mio. cycles
Shielding	Yes
Halogen-free	Yes
Rated voltage cable	300V
Special features	flame retardant, seawater resistant, recyclable, LABS free, RoHs compliant, acid- and alkali resistant, ozone resistant, UV resistant, hydrolysis proof, drag chain-adapted, halogen free, oil resistant, high flexibility, microbes resistant

Classification	
-----------------------	--

eCl@ss 6.0	27279218
eCl@ss 7.0	27279218
eCl@ss 8.0	27279218
eCl@ss 9.0	27060311
ETIM 5.0	EC001855
ETIM 6.0	EC001855

Accessories

Mounting-set, M12
<https://www.escha.net/en/products/standard/accessories-for-connectivity/8047664>

Torque-wrench set
<https://www.escha.net/en/products/standard/accessories-for-connectivity/8055431>

Marking rings Ø 9mm
<https://www.escha.net/en/products/standard/accessories-for-connectivity/?p=1&o=3&n=15&f=809>

Link to product

<https://www.escha.net/en/products/standard/data-connectors/8043885>