

M12, female, angled, 5 poles, M12, male, angled, 5 poles, CANopen/DeviceNet

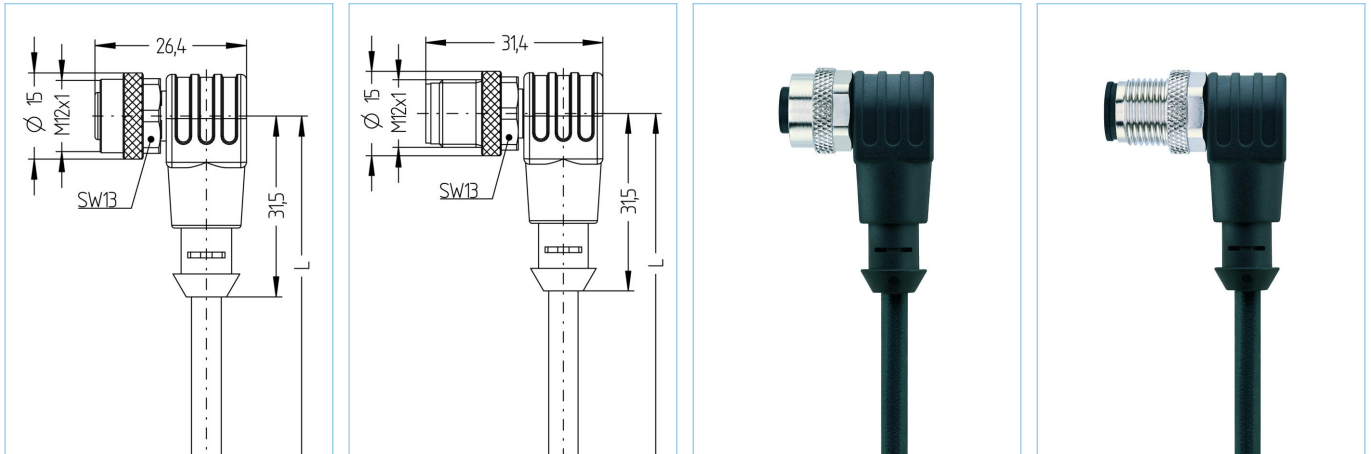

CANopen



Product data		
Item description	CD-WWAK5.022-2-CD-WWAS5.022/S2800	
Item-No.	8047535	
Length	2m	
Customs tariff-No.	85444290	
Step-File	CD-WWAK5-m-CD-WWAS5.stp	
EAN	4047106007171	
Label-carrier	2 pieces	
Technical data	A-side	B-side
Connector	female, angled, M12	male, angled, M12
Number of pins	5	5
Pin assignment	1 (GND), 2 RD (+), 3 BK (-), 4 WH (CAN_H), 5 BU (CAN_L)	1 (GND), 2 RD (+), 3 BK (-), 4 WH (CAN_H), 5 BU (CAN_L)
Coding of	A	A
Rated voltage	60V	60V
Current load (at 40°C)	4A	4A
Insulation resistance	$\geq 10^9 \Omega$	$\geq 10^9 \Omega$
Resistance	$\leq 5 m\Omega$	$\leq 5 m\Omega$
Ambient temperature product	-30°C...+90°C	-30°C...+90°C
Contact material	Metal, CuZn, gold-plated	Metal, CuZn, gold-plated
Contact-carrier material	Plastic, TPU, BK	Plastic, TPU, BK
Grip body material	Plastic, TPU, BK	Plastic, TPU, BK
Coupling nut material	Metal, CuZn, nickel-plated	Metal, CuZn, nickel-plated
Sealing (female) material	FPM/FKM	
Standards	IEC 61076-2-101	IEC 61076-2-101
Degree of protection (mounted)	IP65, IP67, IP68	IP65, IP67, IP68
Mechanical life-cycle	>100 mating cycles	>100 mating cycles
Degree of pollution	3	3

Cable	PUR, UL, S2800, CANopen/DeviceNet
--------------	--

UL- and CSA-listed shielded PUR-cable for automation technology. As a data transmitter, it supports CANopen as well as DeviceNetbased fieldbuses. High transmission rates enable transport of real-time data. Due to the constructive setup and the materials used, increased mechanical stresses (abrasion, bending, vibrations etc.) do not pose any restrictions to the application. Drag-chain application is possible. (>2.5million bending cycles).

Outer diameter of jacket	6.90 mm
Cable-jacket material	PUR
Jacket color	BK, similar RAL9005
Wire cross-section	2 x 0.25 mm ² + 2 x 0.34 mm ²
Wire insulation material	PE/PP
Wire colors	WH, BU, RD, BK
Wire structure	19 x 0.13mm (0.25mm ²), 19 x 0.15mm (0.34mm ²)
Bending radius (fixed)	5 x Ø-cable
Bending radius (repeated)	10 x Ø-cable
Temperature range (repeated)	-25°C...+80°C
Temperature range (fixed)	-50°C...+80°C
Drag chain-application	>2.5Mio. cycles
Shielding	Yes, with stranded wire
Halogen-free	Yes
Rated voltage cable	≤300 V
Special features	flame retardant, seawater resistant, recyclable, LABS free, RoHs compliant, acid- and alkali resistant, ozone resistant, UV resistant, hydrolysis proof, drag chain-adapted, halogen free, oil resistant, microbes resistant

Classification	
-----------------------	--

eCl@ss 6.0	27279218
eCl@ss 7.0	27279218
eCl@ss 8.0	27279218
eCl@ss 9.0	27060311
ETIM 5.0	EC001855
ETIM 6.0	EC001855

Accessories

Mounting-set, M12

<https://www.escha.net/en/products/standard/accessories-for-connectivity/8047664>

Torque-wrench set

<https://www.escha.net/en/products/standard/accessories-for-connectivity/8055431>

Marking rings Ø 9mm

<https://www.escha.net/en/products/standard/accessories-for-connectivity/?p=1&o=3&n=15&f=809>

Link to product

<https://www.escha.net/en/products/standard/data-connectors/8047535>