

M8, male, angled, 3 poles, Food & Beverage

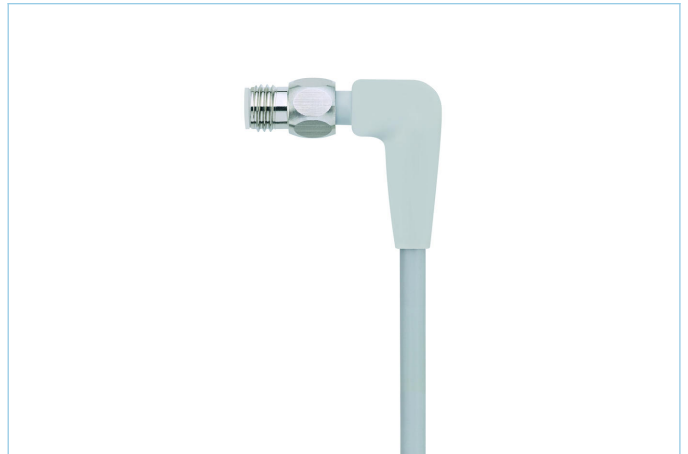
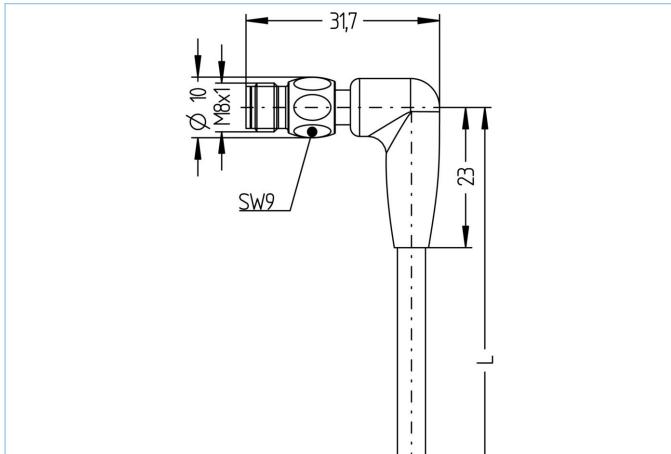

Product data

Item description	FB-SWSPH3-2/S3930
Item-No.	8050460
Length	2m
Customs tariff-No.	85444290
Step-File	FB-SWSPH3.stp
EAN	4047106010232

Technical data

Connector	male, angled, M8
Number of pins	3
Pin assignment	1 BN, 3 BU, 4 BK
Rated voltage	60V
Current load per pin (at 40°C)	4A
Insulation resistance	$\geq 10^9 \Omega$
Ambient temperature product	-40°C...+105°C
Contact material	Metal, CuZn, gold-plated
Contact-carrier material	Plastic, PP, GY
Grip body material	Plastic, PP, transparent
Coupling nut material	Stainless steel, V4A
Standards	IEC 61076-2-104
Degree of protection (mounted)	IP65, IP67, IP68, IP69
Mechanical life-cycle	>100 mating cycles
Cable end assembly	open cable end
Degree of pollution	3
Style	angled

Cable	TPE, S3930, GY
--------------	-----------------------

TPE jacketed cable with elevated position-proof wires with an insulation of special polyester. Resistant to all common acidic- and alkaline cleaning- and disinfection agents. PVC-free plastics prevent discoloration and hardening by detergents. Predestined for applications in the food- and beverage industry. Due to the materials used, it is also suitable for applications in machine- and plant construction. High stability, good drag-chain- and torsion capability.

Outer diameter of jacket	4.60 mm
Cable-jacket material	TPE
Jacket color	GY, similar RAL7035
Wire cross-section	4 x 0.34 mm ²
Wire insulation material	TPE
Wire colors	BN, WH, BU, BK
Wire structure	42 x 0.10 mm
Bending radius (fixed)	5 x Ø-cable
Bending radius (repeated)	10 x Ø-cable
Temperature range (repeated)	-25°C...+105°C
Temperature range (fixed)	-40°C...+105°C
Temperature range (drag chain)	-25°C...+60°C
Halogen-free	Yes
Rated voltage cable	≤240 V _{AC}
Special features	seawater resistant, recyclable, LABS free, RoHs compliant, ozone resistant, hydrolysis proof, drag chain-adapted, torsion resistant, halogen free, excellent acid- and alkali resistant, verified resistance against P3-topactive, flexibility at low temperature, increased thermal load

Classification	
-----------------------	--

eCl@ss 6.0	27279218
eCl@ss 7.0	27279218
eCl@ss 8.0	27279218
eCl@ss 9.0	27060311
ETIM 5.0	EC001855
ETIM 6.0	EC001855

Accessories	
--------------------	--

Mounting-set, M8	
-------------------------	--

<https://www.escha.net/en/products/standard/accessories-for-connectivity/8047663>

Torque-wrench set	
--------------------------	--

<https://www.escha.net/en/products/standard/accessories-for-connectivity/8055431>

Marking rings Ø 9mm	
----------------------------	--

<https://www.escha.net/en/products/standard/accessories-for-connectivity?p=1&o=3&n=15&f=809>

Cable Stripping Tool	
-----------------------------	--

<https://www.escha.net/en/products/standard/accessories-for-connectivity/8066216>

Cable Stripping Tool	
-----------------------------	--

<https://www.escha.net/en/products/standard/accessories-for-connectivity/8066215>

Link to product	
------------------------	--

<https://www.escha.net/en/products/standard/connectors-for-the-food-industry/8050460>