

I/O-junctions passive, 4 ports, fixed cable connection, M8, female, 3 poles

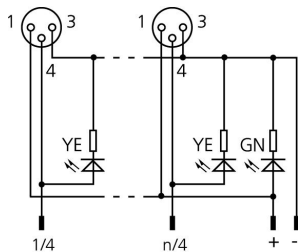
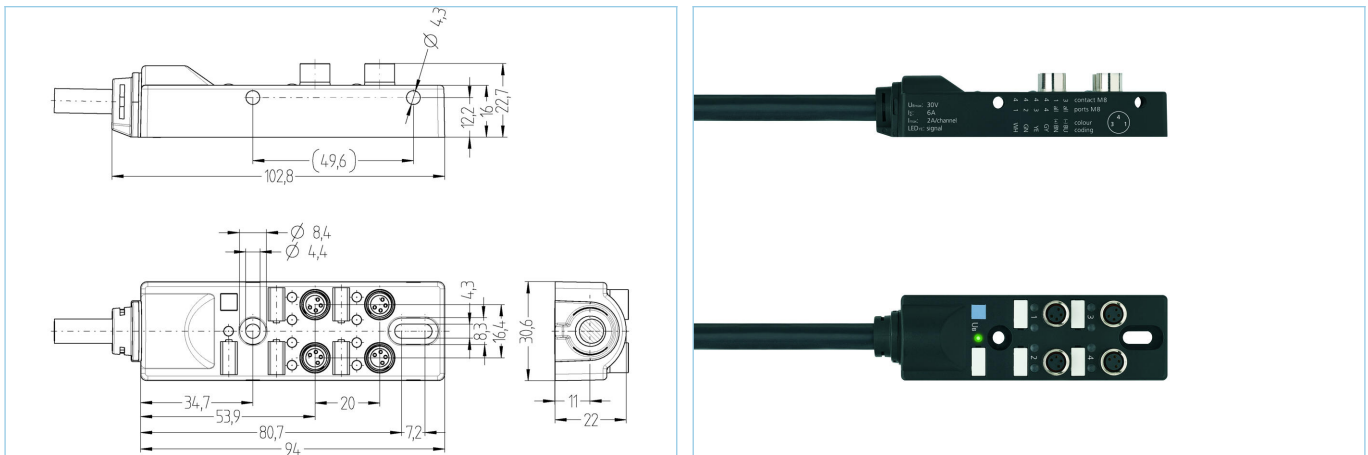

Product data

Item description	4IOM8-3P2C-15/S370
Item-No.	8061778
Length	15m
Customs tariff-No.	85444290
Step-File	4IOM8-3P2C.stp
EAN	4047106148355

Technical data

I/O-junction	10-way, with cable
I/O-slot	female, M8
Number of pins	3
Rated voltage	30V
Current load per pin (at 40°C)	2A
Total current load	6A
Insulation resistance	$\geq 10^9 \Omega$
Resistance	$\leq 5 m\Omega$
Ambient temperature product	-30°C...+90°C
Number of LEDs	5
Number of I/O-slots	4
Circuit logic	npn
Signal status-indicator	LED YE
Operating voltage-indicator	LED GN
Contact material	Metal, CuZn, gold-plated
Contact-carrier material	Plastic, PA, BK
Sealing (female) material	FPM/FKM
Housing material	Plastic, PA, BK
Connecting type	Fixed cable connection

Thread insert material	Metal, CuZn
Standards	IEC 61076-2-104
Degree of protection (mounted)	IP65, IP67
Mechanical life-cycle	>100 mating cycles
Degree of pollution	3

Cable	PUR, UL, S370
--------------	----------------------

Flexible, silicone- and halogen-free control line with high mechanical strength. The cable is chemicals, hydrolysis-, and microbes- resistant. The drag-chain application is possible at a bending radius of minimum 10 x d. Due to its weld-field immunity, the cable is very well suited for the flexible application in robotics, machine-tool, and metal-cutting production. The cables meet the UL and CSA (UL10493/20549; cULus) requirements.

Outer diameter of jacket	6.5 mm
Cable-jacket material	PUR
Jacket color	BK, similar RAL9005
Wire cross-section	4 x 0.25 mm ² + 2 x 0.75 mm ²
Wire insulation material	PP
Wire colors	GY, BN, YE, GN, WH, BU
Bending radius (repeated)	min. 10 x Ø-cable
Temperature range (repeated)	-25°C...+90°C
Temperature range (fixed)	-40°C...+90°C
Drag chain-application	≥5 Mio. cycles
Halogen-free	Yes
Torsion	+/-180°/m, ≥ 0.5 Mio. cycles
Special features	flame retardant, LABS free, RoHs compliant, drag chain-adapted, halogen free

Allocation chart

I/O	1	2	3	4	all (+)	all (-)
Pin	4	4	4	4	1	3
Cable	WH	GN	YE	GY	BN	BU

Classification

eCl@ss 6.0	27279219
eCl@ss 7.0	27279219
eCl@ss 8.0	27279219
eCl@ss 9.0	27440108
ETIM 5.0	EC002585
ETIM 6.0	EC002585

Accessories

Labels, I/O-junction passive, I/O-junction active
<https://www.escha.net/en/products/standard/accessories-for-connectivity/8011349>

Screw plug, M8
<https://www.escha.net/en/products/standard/accessories-for-connectivity/8015075>

Accessories set, I/O-junction passive, I/O-junction active, M8
<https://www.escha.net/en/products/standard/accessories-for-connectivity/8087214>

Link to product

<https://www.escha.net/en/products/standard/io-junctions/8061778>