



Ex safety sensor

Ex HS Si 4 2Ö - 10m

Material number: 1189918 (Material number old: 20473901)

Features/Options:

- Ex zone 1 and 21
- Thermoplastic enclosure
- Hall elements, coded
- Actuation from front

- Switching distance up to 7 mm
- With pre-wired cable
- Attention: Please state required international approvals with your order!

Notes

- The actuator is not included in the delivery of the switches

Dimensions

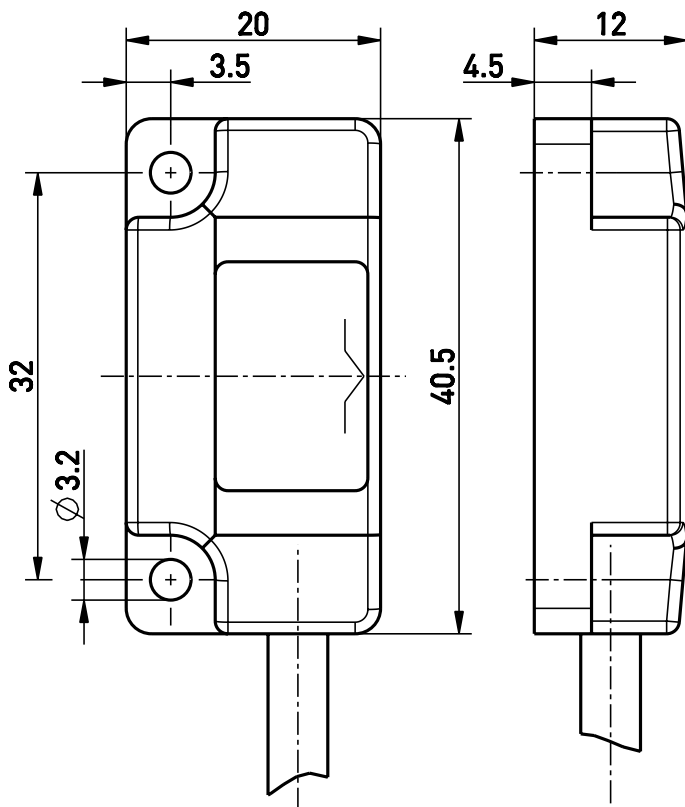

Technical data

Applied standards	EN 60079-0, EN 60079-18, EN 60947-5-2, EN 60947-5-3, EN ISO 14119, EN ISO 13849-1, EN 62061
Enclosure	thermoplastic, glass-fibre reinforced, impact resistant, self-extinguishing UL 94 V-0
Sensor type	type 4 interlocking device
Coding level	low coding
Degree of protection	IP 66, IP 67, IP 69 (IEC/EN 60529) / IP 69K (ISO 20653)
Safety-relevant data:	
EN ISO 13849-1	Performance Level PL e
Category	4
T_M	max. 20 years
$MTTF_d$	> 100 years
DC/DC_{avg}	> 99 %
EN 62061	SIL CL 3
PFH_d	$\geq 2.47 \times 10^{-8}$ 1/h
Note	The safety-related data are only valid in combination with a safety module, e.g. SRM 21 RT2 (mat. no. 1179203).
Switching system	Hall sensor, 2 galvanically separated channels, semiconductor
Switching elements	2 NC contacts
Connection	cable 6 x AWG 26
Cable length	10 m

Errors and omissions excepted.



Ex safety sensor

Ex HS Si 4 2Ö - 10m

Material number: 1189918 (Material number old: 20473901)

Technical data

Rated operating voltage U_e	24 VDC
Rated operating voltage range U_B	10 ... 30 VDC
Rated operating current I_e	max. 40 mA per channel
Utilisation category	DC-12
No-load supply current I_0	max. 6 mA per channel
Voltage drop at I_e	max. 2.5 V
Switch-on/switch-off time	< 1 ms
Short-circuit protection	< 50 mA internal reversible fuse
Switching frequency	max. 100 Hz
Safety class	II
Degree of pollution	3
Ambient temperature	-20 °C ... +60 °C
Mechanical life	> 10 million operations
Rated switching distance s_n	7 mm
Assured switching distance »ON« s_{ao}	6 mm
Assured switching distance »OFF« s_{ar}	20 mm
Repeatability	≤ 5 %
Impact energy	max. 7 J
Ex marking	II 2G Ex mb IIC T6 Gb, II 2D Ex mb IIIC T80°C Db IECEX Ex mb IIC T6 Gb Ex mb IIIC T80°C Db
Approvals	BVS 08 ATEX E 150 X IECEX BVS 08.0054X
Weight	318 g

Errors and omissions excepted.



Ex safety sensor

Ex HS Si 4 2Ö - 10m

Material number: 1189918 (Material number old: 20473901)

Contact diagram

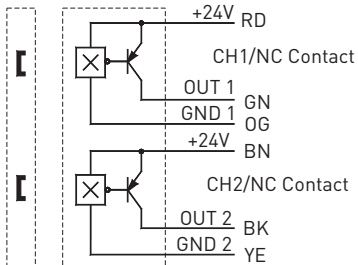

Axial misalignment

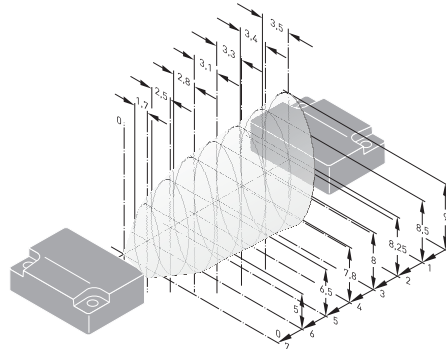

Errors and omissions excepted.