



Position switch with safety function

ES 98 PH-21

Material number: 1309206 (Material number old: 9104190001)

Features/Options:

- Metal enclosure
- Design to EN 50041
- Slow action \ominus , 1 NC/2 NO contact with double break
- Actuator: Parallel roller lever PH

- Actuating speed max. 0.5 m/s with an actuating angle of 30°
- Actuation parallel to switch from below
- Wear-resistant plastic roller
- Actuator can be repositioned by 4 x 90°

Notes

- Actuation from the left should be avoided since this reduces the mechanical life of the position switch.

Dimensions

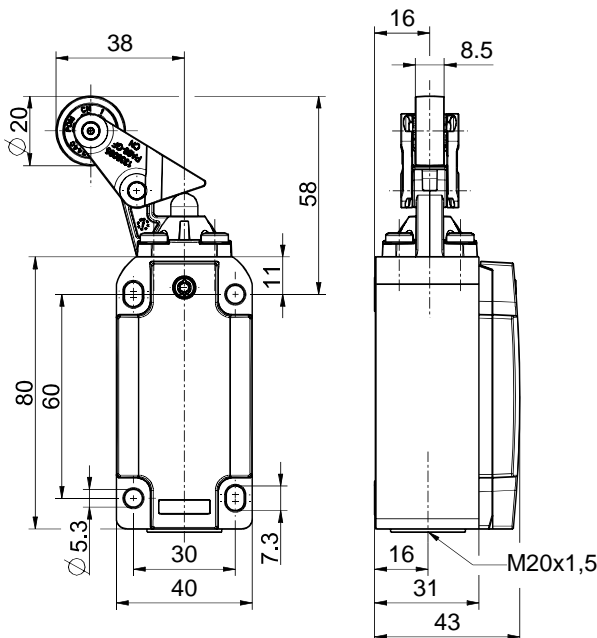

Technical data

Applied standards	EN ISO 13849-1, EN 60947-5-1, EN ISO 14119
Enclosure	aluminium die-cast, powder-coated
Switch type	type 1
Coding level	no coding
Degree of protection	IP 67 to IEC/EN 60529
B _{10d} (10 % load)	2 million
T _M	max. 20 years
Contact material	silver
Switching system	slow action, positive break NC contacts \ominus
Switching elements	1 NC/2 NO contact, type Zb
Connection	screw connection terminals
Cable cross-section	max. 1.5 mm ² (incl. conductor ferrules)
Cable entry	1 x M20 x 1.5
Rated impulse withstand voltage U _{imp}	4 kV
Rated insulation voltage U _i	400 V
Conventional thermal current I _{the}	1.5 A
Rated operating current/voltage I _e /U _e	1.5 A/230 VAC; 0.27 A/250 VDC
Utilisation category	AC-15; DC-13
Short-circuit protection	1.5 A gG/gN fuse
Mechanical life	> 1 million operations

Errors and omissions excepted.



Position switch with safety function

ES 98 PH-21

Material number: 1309206 (Material number old: 9104190001)

Technical data

Operation cycles	max. 1800/h
Ambient temperature	-20 °C ... +80 °C

Approvals



Contact diagram

