



Ex emergency pull-wire switch

Ex ZS 75 2Ö/2S WVD / 295-390 N - 3m

Material number: 1048370 (Material number old: 75342301)

Features/Options:

- Ex zone 1 and 21
- Metal enclosure
- 4 contacts
- Wire length up to 130 m
- Adjustable spring force: 295-390 N
- Release by push button (VD)
- Wire pull and breakage detection
- Watertight collar W for protection against penetration of dirt
- Attention: Please state required international approvals with your order!

Notes

- At 5 m distance intermediate wire supports are required. One wire thimble is provided.

Dimensions

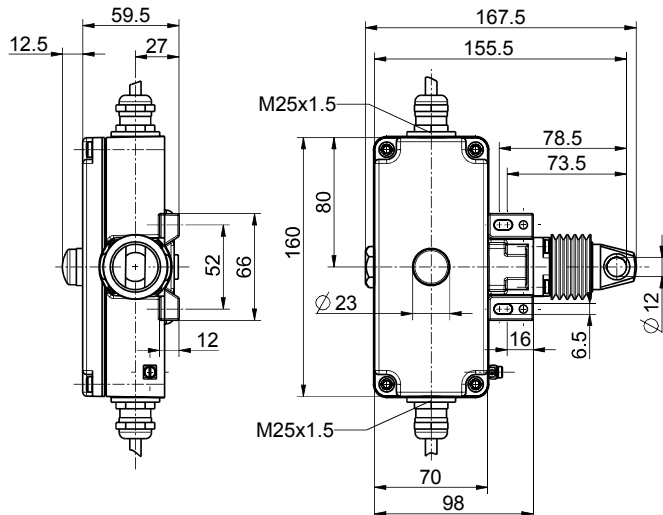

Technical data

Applied standards	EN 60947-5-1, EN 60947-5-5, EN 60079-0, EN 60079-1, EN 60079-31, EN ISO 13850, EN ISO 13849-1
Enclosure	aluminium die-cast, powder-coated
Cover	aluminium die-cast, powder-coated
Degree of protection	IP 65 to IEC/EN 60529
B _{10d} (10 % load)	200 000
T _M	max. 20 years
Switch insert	2 x Ex 14
Contact material	silver
Switching system	slow action, positive break NC contacts ⊖
Switching elements	2 NC/2 NO contacts, type Zb
Connection	pre-wired cable H05VV-F
Cable length	3 m
Cable cross-section	4 x 0.75 mm ² (incl. conductor ferrules) per switch insert
Rated impulse withstand voltage U _{imp}	4 kV
Rated insulation voltage U _i	250 V
Conventional thermal current I _{the}	T6: 6 A, T5: 3 A
Utilisation category	AC-15; DC-13
Rated operating current/voltage I _e /U _e	6 A/250 VAC; 0.25 A/230 VDC

Errors and omissions excepted.







Ex emergency pull-wire switch

Ex ZS 75 2Ö/2S WVD / 295-390 N - 3m

Material number: 1048370 (Material number old: 75342301)

Technical data

Short-circuit protection	6 A gG/gN fuse
Ambient temperature	T6: -20 °C ... +65 °C, T5: -20 °C ... +75 °C, +90 °C with max. 3 A
Mechanical life	> 100 000 operations
Max. wire length	130 m
Impact energy	max. 7 J
Ex marking	⊕ II 2G Ex d IIC T6/T5 Gb, ⊕ II 2D Ex tb IIIC T80 °C/T95 °C Db IECEX Ex d IIC T6/T5 Gb, Ex tb IIIC T80 °C/T95 °C Db
Approvals	PTB 11 ATEX 1003 X IECEX PTB 07.0034 X     
Weight	1560 g

Switching diagram

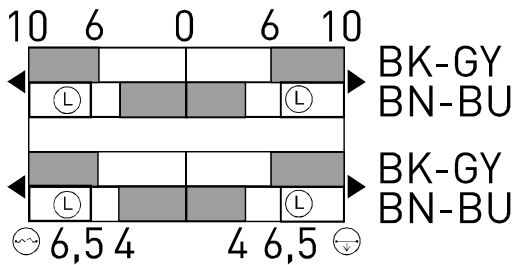

- ⊕ Latching point
- ⊕ Wire breakage detection
- ⊖ Wire pull detection

Errors and omissions excepted.