



Ex position switch Ex EM 99 DS-11 -60°C X Material number: 1442717

Features/Options:

- Ex zone 1 and 21
- Thermoplastic enclosure
- Cold-resistant down to -60 °C
- High degree of protection IP 66 / IP 67 / IP 69
- Design to EN 50041

Notes

- 1 Ex"e" cable gland M20x1.5 included in delivery

Dimensions

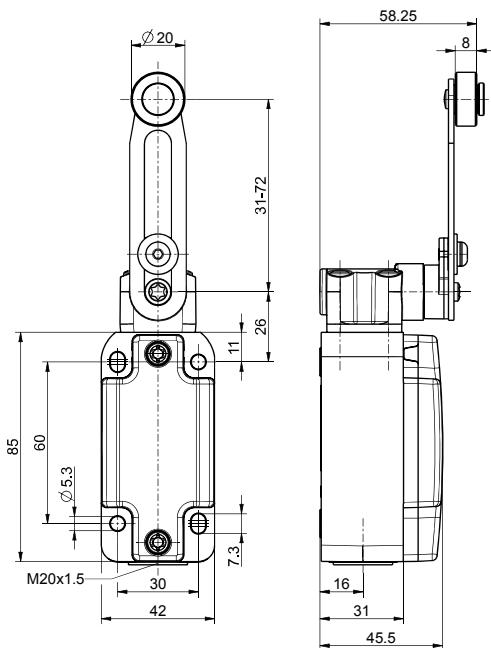

Technical data





Applied standards	EN 60947-5-1, EN 60079-0, EN 60079-1, EN 60079-7, EN 60079-31
Enclosure	thermoplastic, glass-fibre reinforced, impact resistant, self-extinguishing UL 94 V-0
Cover	thermoset, glass-fibre reinforced, impact resistant, self-extinguishing UL 94 V-0
Sealing	silicone
Tightening torque	cover screws: 1.5 ... 2 Nm connecting thread of cable gland: max. 2 Nm cap nut of cable gland: max. 5 Nm
Degree of protection	IP 66 (EN 60079-0 + IEC/EN 60529) IP 67, IP 69 (IEC/EN 60529) IP 69K (ISO 20653)
Switch insert	1 x 8080/1-1
Contact material	Silver, nickel-plated
Switching system	snap action
Switching elements	1 NC/1 NO contact, type Zb
Connection	screw connection terminals
Cable cross-section	min. 0,75 mm ² / AWG 18, max. 1,5 mm ² / AWG 16, incl. conductor ferrules
Cable entry	M20 x 1,5; screwing depth max. 9 mm; use only Ex approved and certified cable glands with min. degree of protection IP 66 and suitable for the specified ambient temperature range
Clamping range	7 ... 12 mm
Utilisation category	AC-15

Errors and omissions excepted.



Ex position switch
 Ex EM 99 DS-11 -60°C X
 Material number: 1442717

Technical data

Rated operating current I_e	max. 2 A or 4 A <input type="checkbox"/>
Rated operating voltage U_e	max. 500 VAC, max. 250 VAC for unequal potential
Degree of pollution	3
Mechanical life	> 1 million operations
Temperature class	T6
Ambient temperature	-60 °C ... +55 °C max. 4 A, +60 °C max. 2 A
Impact energy	max. 7 J down to -40 °C max. 4 J down to -60 °C
Short-circuit protection	2 A / 4 A gG/gN fuse
Ex marking	<p>⊕ II 2G Ex db eb IIC T6 Gb, ⊕ II 2D Ex tb IIIC T80 °C Db IECEX Ex db eb IIC T6 Gb, Ex tb IIIC T80 °C Db</p>
Approvals	<p>BVS 16 ATEX E113 X IECEX BVS 16.0076X</p> <p>      </p>
Weight	250 g

Contact diagram

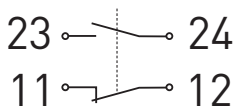

Switching diagram

