



Ex emergency pull-wire switch

Ex ZS 71 2Ö WVD / 100 N - 3m

Material number: 1189336 (Material number old: 71542311)

Features/Options:

- Ex zone 1 and 21
- Metal enclosure
- 2 contacts
- Compact design
- Wire length up to 35 m
- Spring force variant: 100 N

Notes

- At 3 m distance intermediate wire supports are required. One wire thimble is provided.

- Release by push button (VD)
- Wire pull and breakage detection
- Watertight collar W for protection against penetration of dirt
- Attention: Please state required international approvals with your order!

Dimensions

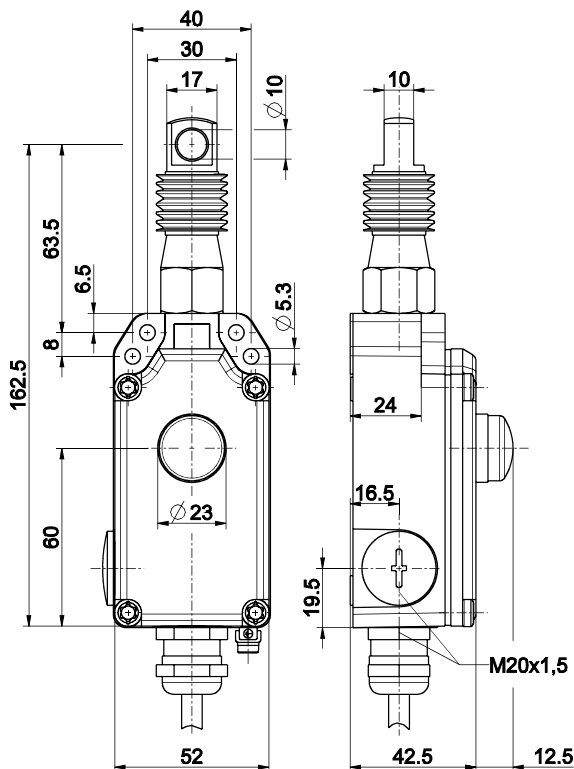

Technical data

Applied standards	EN 60947-5-1, EN 60947-5-5, EN 60079-0, EN 60079-1, EN 60079-31, EN ISO 13850, EN ISO 13849-1
Enclosure	aluminium die-cast, powder-coated
Cover	thermoplastic, glass-fibre reinforced, impact resistant, self-extinguishing UL 94 V-0
Degree of protection	IP 65 to IEC/EN 60529
B _{10d} (10 % load)	200 000
T _M	max. 20 years
Switch insert	1 x Ex 14
Contact material	silver
Switching system	slow action, positive break NC contacts ⊖
Switching elements	2 NC contacts, type Zb
Connection	pre-wired cable H05VV-F
Cable length	3 m
Cable cross-section	4 x 0.75 mm ² (incl. conductor ferrules)
Rated impulse withstand voltage U _{imp}	4 kV
Rated insulation voltage U _i	250 V
Conventional thermal current I _{the}	T6: 6 A, T5: 3 A
Utilisation category	AC-15; DC-13

Errors and omissions excepted.









Ex emergency pull-wire switch

Ex ZS 71 2Ö WVD / 100 N - 3m

Material number: 1189336 (Material number old: 71542311)

Technical data

Rated operating current/ voltage I_e/U_e	6 A/250 VAC; 0.25 A/230 VDC
Short-circuit protection	6 A gG/gN fuse
Ambient temperature	T6: -20 °C ... +65 °C, T5: -20 °C ... +75 °C, +90 °C with max. 3 A
Mechanical life	> 100 000 operations
Max. wire length	35 m
Impact energy	max. 7 J
Ex marking	<p>⊕ II 2G Ex d IIC T6/T5 Gb, ⊕ II 2D Ex tb IIIC T80 °C/T95 °C Db IECEX Ex d IIC T6/T5 Gb, Ex tb IIIC T80 °C/T95 °C Db</p>
Approvals	<p>PTB 11 ATEX 1003 X IECEX PTB 07.0034 X</p> <p>        </p>
Weight	674 g

Switching diagram

