



Position switch

EM 14 - 5m

Material number: 1163617 (Material number old: 14701007)

Features/Options:

- Thermoplastic enclosure
- Double insulated
- Mounting details to EN 50047
- Suitable for in-line mounting
- With pre-wired cable
- Actuator: Plunger
- Actuating speed max. 0.5 m/s with a vertical actuating angle of 0°

Dimensions

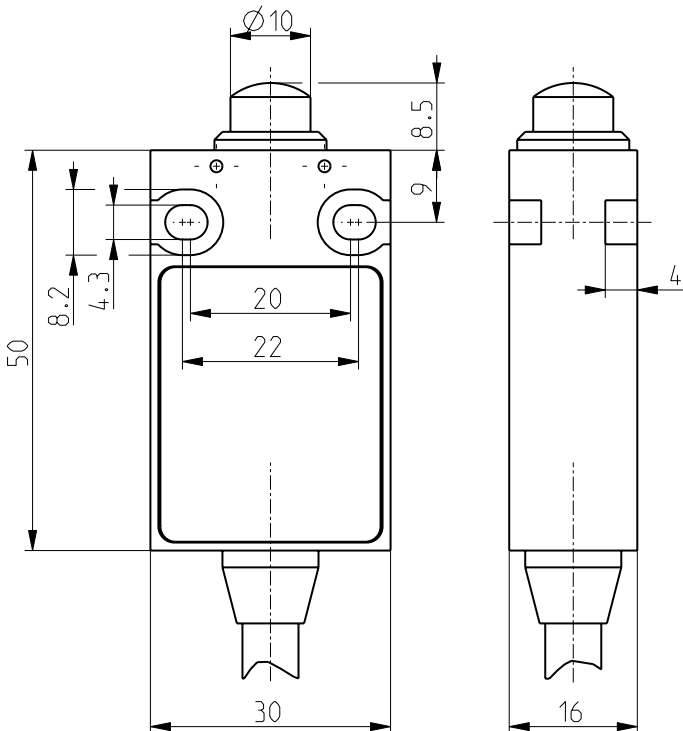

Technical data

Applied standards	EN 60947-5-1
Enclosure	thermoplastic, glass-fibre reinforced, impact resistant, self-extinguishing UL 94 V-0
Degree of protection	IP 67 to IEC/EN 60529
Contact material	silver
Switching system	snap action
Switching elements	1 change-over contact with single break, type C
Connection	pre-wired cable H05VV-F
Cable cross-section	3 x 0.75 mm ²
Cable length	5 m
Rated impulse withstand voltage U_{imp}	4 kV
Rated insulation voltage U_i	250 V
Conventional thermal current I_{the}	5 A
Rated operating current/voltage I_e/U_e	5 A/250 VAC; 0.16 A/230 VDC
Utilisation category	AC-15; DC-13
Short-circuit protection	5 A gG/gN fuse
Ambient temperature	-20 °C ... +75 °C
Mechanical life	> 1 million operations
Operation cycles	max. 1800/h
Repeat accuracy of switching points	± 0.1 mm
Contact opening	max. 2 x 4 mm
Approvals	
Weight	383 g

Errors and omissions excepted.



Position switch

EM 14 - 5m

Material number: 1163617 (Material number old: 14701007)

Contact diagram

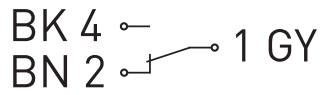

Switching diagram

