



## Ex position switch with safety function

Ex 14 FR 1Ö/1S - 5m

Material number: 1045447 (Material number old: 14051302)

### Features/Options:

- Ex zone 1 and 21
- Thermoplastic enclosure
- Double insulated
- Mounting details to EN 50047
- With pre-wired cable
- Actuator: Roller plunger for front mounting FR

- Actuating speed max. 0.5 m/s with a vertical actuating angle of 25°
- Metal roller
- Attention: Please state required international approvals with your order!

### Notes

- Actuator can be repositioned by 90° on request

### Dimensions

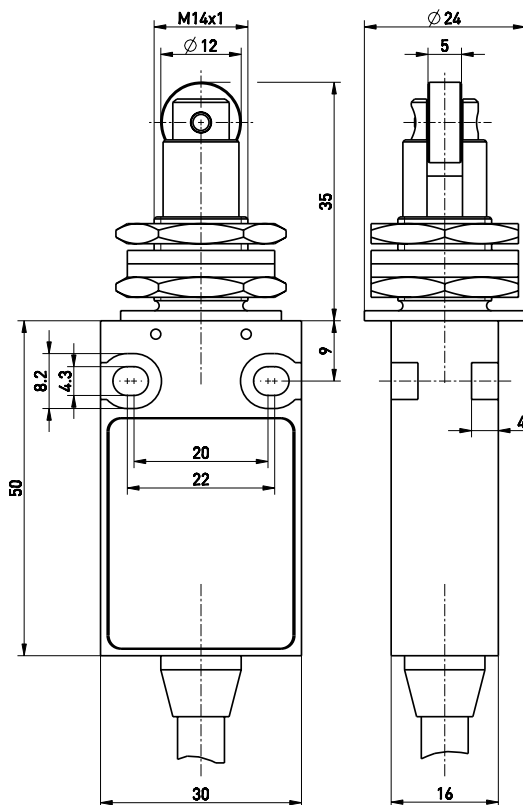

### Technical data

Applied standards	EN 60947-5-1, EN 60079-0, EN 60079-1, EN 60079-31, EN ISO 13849-1, EN ISO 14119
Enclosure	thermoplastic, glass-fibre reinforced, impact resistant, self-extinguishing UL 94 V-0
Switch type	type 1
Coding level	no coding
Degree of protection	IP 65 to IEC/EN 60529
B <sub>10d</sub> (10 % load)	2 million
T <sub>M</sub>	max. 20 years
Contact material	silver
Switching system	slow action, positive break NC contacts $\ominus$
Switching elements	1 NC/1 NO contact, type Zb
Connection	pre-wired cable H05VV-F
Cable cross-section	4 x 0.75 mm <sup>2</sup> (incl. conductor ferrules)
Cable length	5 m
Rated impulse withstand voltage U <sub>imp</sub>	4 kV
Rated insulation voltage U <sub>i</sub>	250 V
Conventional thermal current I <sub>the</sub>	T6: 6 A, T5: 3 A
Rated operating current/voltage I <sub>e</sub> /U <sub>e</sub>	6 A/250 VAC; 0.25 A/230 VDC
Utilisation category	AC-15; DC-13
Short-circuit protection	6 A gG/gN fuse

Errors and omissions excepted.



## Ex position switch with safety function

Ex 14 FR 1Ö/1S - 5m

Material number: 1045447 (Material number old: 14051302)

### Technical data

Ambient temperature	T6: -20 °C ... +65 °C, T5: -20 °C ... +75 °C, +90 °C with max. 3 A
---------------------	--

Mechanical life	> 1 million operations
-----------------	------------------------

Operation cycles	max. 1800/h
------------------	-------------

Repeat accuracy of switching points	± 0.1 mm
-------------------------------------	----------

Contact opening	max. 2 x 4 mm
-----------------	---------------

Ex marking	II 2G Ex db IIC T6/T5 Gb, II 2D Ex tb IIIC T80 °C/T95 °C Db IECEX Ex db IIC T6/T5 Gb, Ex tb IIIC T80 °C/T95 °C Db
------------	---

Approvals	PTB 03 ATEX 1070 X IECEX PTB 06.0098X
-----------	--



Weight	455 g
--------	-------

### Contact diagram

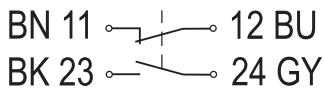

### Switching diagram

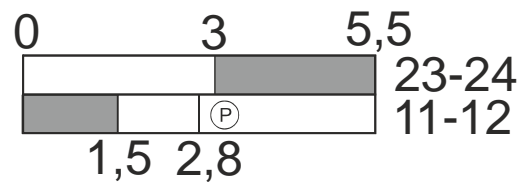

Ⓟ Positive break travel/angle