



Ex magnetic sensor

Ex RC 13,5 1S - 5m

Material number: 1173350 (Material number old: 21323501)

Features/Options:

- Ex zone 1 and 21
- Brass enclosure, nickered
- Actuation from front
- Switching distance up to 30 mm depending on the actuating magnet

- With pre-wired cable
- Attention: Please state required international approvals with your order!

Notes

- 2 mounting nuts are included in delivery
- The actuator is not included in the delivery of the switches

Dimensions

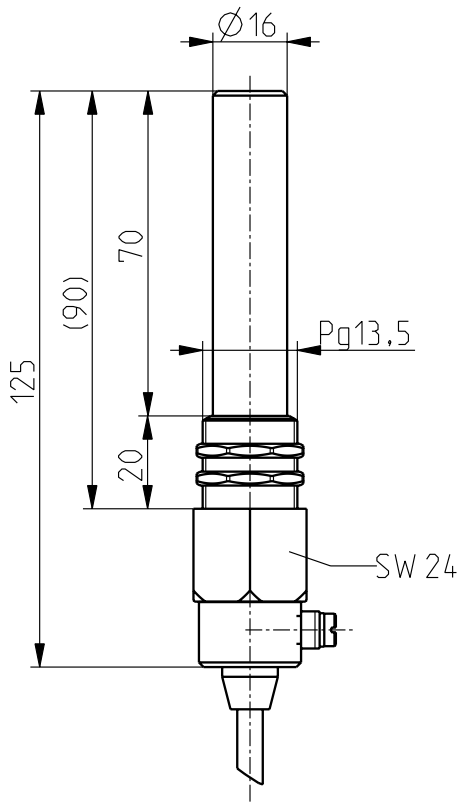

Technical data

Applied standards	EN 60947-5-2, EN 60079-0, EN 60079-18
Enclosure	brass, nickered
Degree of protection	IP 67 to IEC/EN 60529
Switching system	reed contacts
Switching elements	1 NO contact
Connection	pre-wired cable H05VV-F
Cable cross-section	3 x 0.75 mm ²
Cable length	5 m
Switching voltage	max. 250 VAC/DC
Switching current	max. 1.5 A
Short-circuit current I _k	max. 5 A
Switching capacity	max. 100 W/VA
Bounce duration	max. 5 ms
Ambient temperature	-20 °C ... +70 °C
Mechanical life	> 1 million operations
Vibration resistance	max. 30 g
Shock resistance	max. 100 g
Impact energy	max. 7 J
Ex marking	⊕ II 2G Ex mb IIC T6 Gb, ⊕ II 2D Ex mb IIC T80 °C Db IECEX Ex mb IIC T6 Gb Ex mb IIC T80 °C Db

Errors and omissions excepted.



Ex magnetic sensor

Ex RC 13,5 1S - 5m

Material number: 1173350 (Material number old: 21323501)

Technical data

Approvals

DMT 01 ATEX E 058 X
IECEX BVS 07.0007 X



Weight

520 g

Contact diagram

BU  BN