



Ex safety sensor

Ex RC Si M30 1Ö/1S - 2m

Material number: 1179282 (Material number old: 23003201)

Features/Options:

- Ex zone 1 and 21
- Metal enclosure
- Reed contacts, coded
- Actuation from front

Notes

- 2 mounting nuts are included in delivery
- The actuator is not included in the delivery of the switches

- Switching distance up to 10 mm
- Attention: Please state required international approvals with your order!

Dimensions

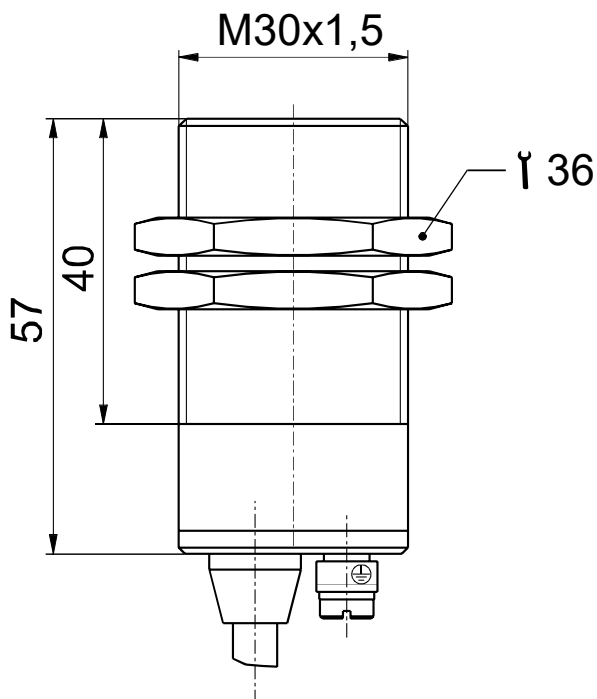

Technical data

Applied standards	EN 60947-5-1, EN 60947-5-3, EN 60079-0, EN 60079-18, EN ISO 13849-1, EN ISO 14119
Enclosure	brass, nicked
Sensor type	type 4 interlocking device
Coding level	low coding
Tightening torque	mounting nut: max. 75 Nm
Degree of protection	IP 67 to IEC/EN 60529
Safety-relevant data:	
EN ISO 13849-1	Performance Level PL e
Category	4
B _{10d} (10 % load)	20 million
T _M	max. 20 years
MTTF _d	> 100 years
DC/DC _{avg}	> 99 %
h _{op}	8 h/day
d _{op}	220 days/year
t _{zyklus}	20 s
Note	The safety-related data are only valid in combination with a safety module, e.g. SRM 21 RT2 (mat. no. 1179203).
Switching system	reed contacts
Switching elements	1 NC/1 NO contact
Connection	cable H05VV5-F 5G

Errors and omissions excepted.



Ex safety sensor
Ex RC Si M30 1Ö/1S - 2m
Material number: 1179282 (Material number old: 23003201)

Technical data

Cable cross-section	5 x 0.5 mm ²
Cable length	2 m
Switching voltage	max. 30 VAC/DC
Rated operating current/ voltage I_e/U_e	max. 125 mA / 24 VDC
Switching capacity	max. 3.75 W
Voltage drop at I_e	max. 2.5 V
Short-circuit current I_k	max. 750 mA for 50 ms
Operation cycles	max. 1600/h
Rated switching distance s_n	10 mm
Assured switching distance »ON« s_{ao}	8 mm
Assured switching distance »OFF« s_{ar}	30 mm
Repeatability	± 0.5 mm
Hysteresis	approx. 14 mm
Temperature class	T6
Ambient temperature	-20 °C ... +70 °C
Mechanical life	> 10 million operations
Impact energy	max. 7 J
Ex marking	II 2G Ex mb IIC T6 Gb, II 2D Ex mb IIIC T80°C Db IP67 IECEX Ex mb IIC T6 Gb, Ex mb IIIC T80°C Db IP67
Approvals	PTB 05 ATEX 2024 X IECEX PTB 07.0008 X
Weight	360 g

Errors and omissions excepted.



Ex safety sensor

Ex RC Si M30 1Ö/1S - 2m

Material number: 1179282 (Material number old: 23003201)

Contact diagram

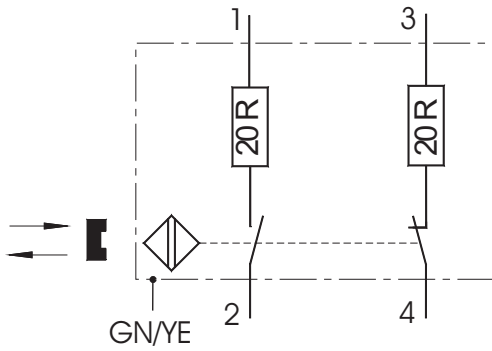

Axial misalignment

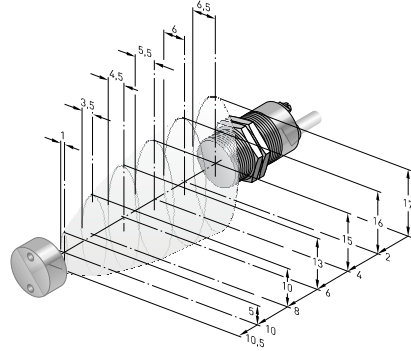

Errors and omissions excepted.